



- ARC/HRC/ERC Standard 4-Row Ball Bearing Linear Guide
- WRC Wide 4-Row Ball Bearing Linear Guide
- ARD/HRD/ERD Standard 4-Row Ball Bearing Linear Guide Equipped with Cover Strip
- ARR/HRR/LRR Standard 4-Row Roller-type Linear Guide

* cpc reserves the right to revise any information(technical details) any time without notice, for printing mistakes or any other incidental mistakes. We take no responsibility.

cpc CHIEFTEK PRECISION Co., LTD.

HEADQUARTERS
CHIEFTEK PRECISION Co., Ltd.
 No.3, Dali 1st Rd., Xinsih Dist., Southern Taiwan
 Science Park, Tainan City 741-45, Taiwan (R.O.C)
 TEL:+886-6-505 5858 Http://www.chieftek.com
 E-mail:service@mail.chieftek.com

CHIEFTEK PRECISION USA
 2280 E. Locust Court,
 Ontario, CA 91761, USA
 Tel:+1-909-773-1200
 Fax:+1-909-773-1202

cpc Europa GmbH
 Industriepark 314,
 D-78244 Gottmadingen, Germany
 TEL:+49-7731-59130-38
 FAX:+49-7731-59130-28

CHIEFTEK MACHINERY KUNSHAN Co., Ltd.
 No.1188, Hongqiao Rd, Kunshan,
 Jiangsu, P.R. China
 TEL:+86-512-5525 2831
 FAX:+86-512-5525 2851



Contents

ARC/HRC/ERC Standard 4-Row Ball Bearing Linear Guide

ARC/HRC/ERC Product Overview.....	P01~P02
Product Design (Standard Equipment).....	P03~P06
Product Design (Optional Accessories).....	P07~P12
Technical Information.....	P13~P25
Installation Instructions.....	P26~P29
Lubrication.....	P30
Accuracy.....	P31
Ordering Information.....	P32
Dimensions Specification.....	P33~P40

WRC Wide 4-Row Ball Bearing Linear Guide

Ordering Information.....	P42
Dimensions Specification.....	P43~P44

ARD Standard 4-Row Ball Bearing Linear Guide Equipped with Cover Strip

Product Features.....	P45
Installation Instructions.....	P46
Ordering Information.....	P46
Dimensions Specification.....	P47~P54

ARR/HRR/LRR 4-Row Roller-type Linear Guide

Product Design.....	P55~P60
Technical Information.....	P61~P62
Accuracy.....	P63~P64
Ordering Information.....	P65~P66
Dimensions Specification.....	P67~P76

Bellows

Bellows.....	P77~P78
--------------	---------

Grease Nipple Option

Grease Nipple Option.....	P79~P80
Lubrication Kit and Grease Gun.....	P81~P82

Lubrication Storages Pad Testing Report

Lubrication Storages Pad Test Report.....	P83
Linear Guide Service Life Calculation and Model Selection.....	P84

Selection method

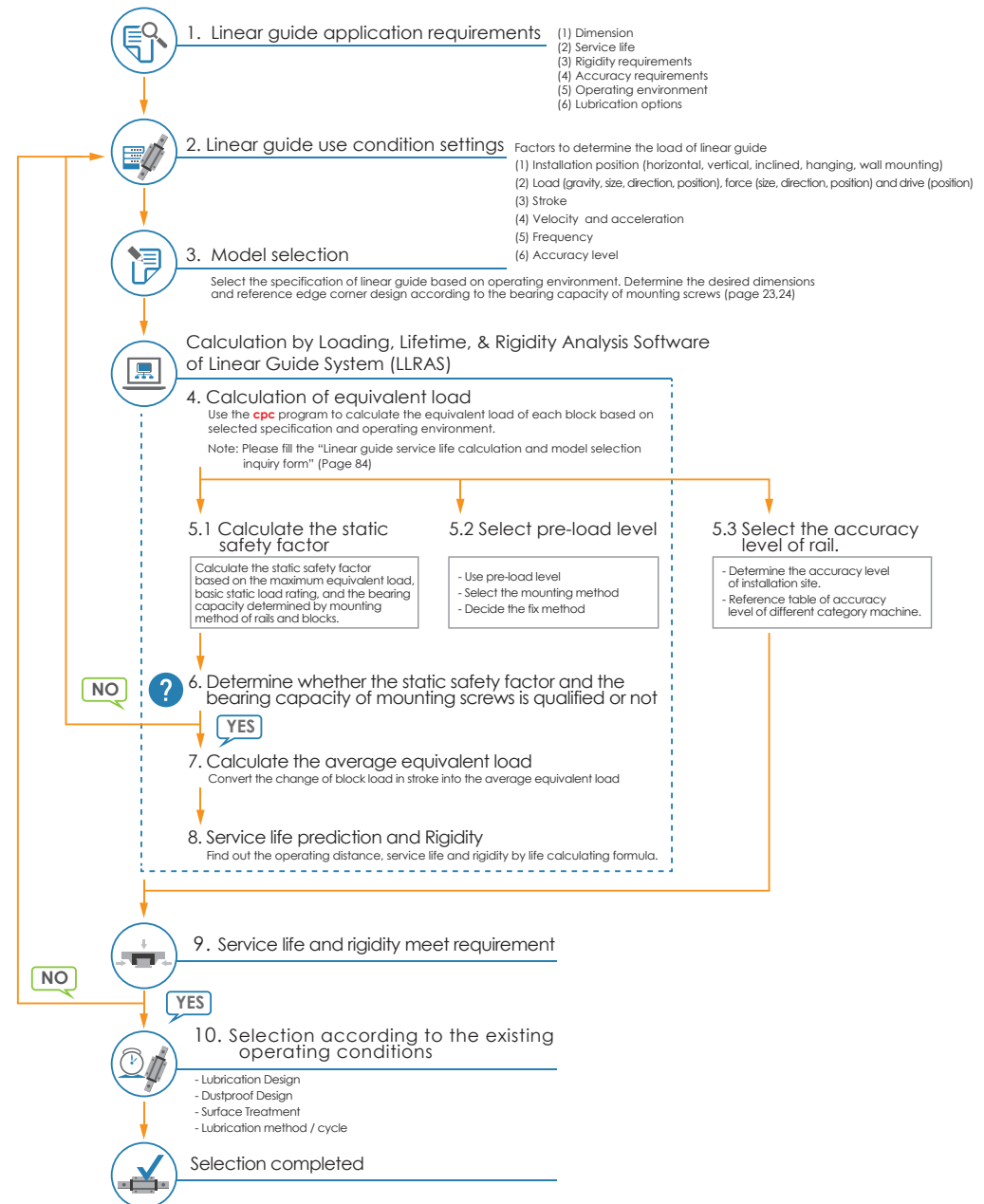

Product Overview

ARC/HRC/ERC Product Characteristics

Our standard **cpc** ARC/HRC/ERC Linear Guide Series uses the O-type arrangement for its four-row ball circulation design. The 45-degree contact angle between the rails and balls allows our product to realize a four-directional equivalent load effect. **cpc** has placed special emphasis on strengthening the arm length (Lo) of our product so that when sustaining external force (F), this can have an even higher Mr value, which increases its rigidity and torsion-resistant capabilities. The larger and more numerous balls in our products allows it to have a 10-30% greater load capacity than similarly sized competitor products. These and other characteristics are the source of our product's high load capacity, moment, and stiffness features.

Mode Code	Lo	Hc
15	12.4	9.35
20	16.4	12.5
25	19.5	14.5
30	24.0	17
35	30.4	19.5
45	38.2	24
55	43.1	28.5

Unit:mm

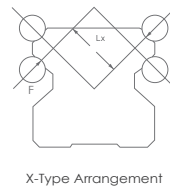
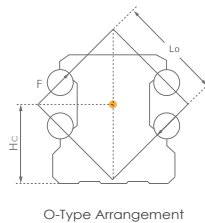

$$F = Mr/Lo (Lx)$$

Stainless steel reinforcement plate

- Total scraping of external objects above 0.3mm
- Increased X-axis axial force capacity

Inner Lubrication storage Pad (Upper)

- No need to increase the length of the runner block
- Full lubrication contact with balls, particularly suitable for short stroke movement.

End Cap

- All-around lubrication holes system

High abrasion resistant material end seal

- Standard contactless, low friction, high dust proof seal

Inner Lubrication storage Pad (Bottom)

Ball chain

- Patented design to enable reverse operations.
- Muted and prolonged service life

- High Load and torque capabilities
- Excellent dynamic performance: Reach Vmax 10 m/s Reach a_{max} 450 m/s²
- Can provide counterbored holes from the top and tapped mounting holes from the bottom rail
- Can provide specialized steel surface treatment

Product Design (Standard)

Dustproof design

Inner Seals

The newly designed inner seals both protect the rails from foreign particles and keep the lubrication inside the runner block while maintaining a low friction profile.

Stainless Steel Reinforcement Plate

The reinforcement plate also functions as a scraper for larger particulates like iron fillings, and has no more than 0.3mm clearance between the plate and the rail.

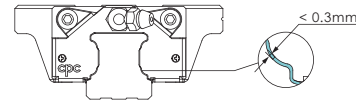

Bottom Seals

The bottom seals work in conjunction with the inner seals to keep foreign particles out and lubrication from leaking out. Our comprehensive sealing design significantly reduces re-lubrication needs and prolongs the service life of the runner block.

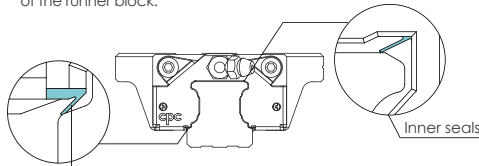

Bottom Seals

End Seals

The end seals work in conjunction with the bottom and inner seals to block foreign particles out and prevent lubrication leakage. Our engineering plastic has a strong friction resistance and is less prone to cracking than typical NBR plastics.

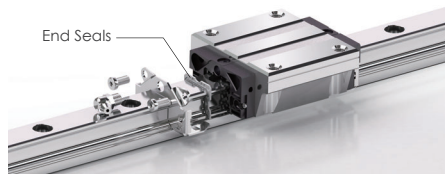

Standard Seals (S)

Our standard seals are in direct contact with the rail surface, giving them increased dustproof and lubrication retention capabilities. **cpc** recommends this class of seal for blocks that operate in environments high in foreign particles, such as sawdust, for long periods of time. S-type seals will have comparatively higher friction than B-Type seals.

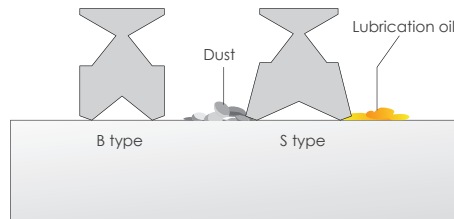

Low Friction Seals (B)

Our low-friction seals have slight contact with the rail and are suitable for most environments, with both low friction and a scraper function.

Seal type friction comparison

Friction levels will be the highest on new linear rails. But, after short periods of operation, such friction will be reduced to a constant level.

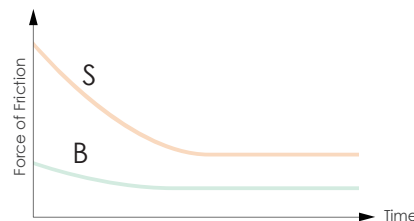

Average Friction of Block

The following table shows the resistance value of the running block mounted with different seal types under the condition when the running block lubricated with ISO VG32 lubricant.

Unit : N

Block Type	ARC/HRC/ERC							
	Friction caused from ball bearing				Bottom Seals + Inner Seals	End Seals (2 sides)		External NBR seal with metal scraper
	Preload Class					S-Type Standard	B-Type Low friction	
VC	V0	V1	V2					
15MN/FN	0.30	0.65	0.85	1.10	1.5	2.0	0.5	4
20MN/FN	0.40	0.75	1.40	1.60	2.0	2.5	1.0	5
25MN/FN	0.60	0.95	1.60	1.95	2.5	3.0	1.5	8
30MN/FN	0.55	1.10	2.00	3.10	3.0	5.0	2.0	10
35MN/FN	0.65	1.25	2.50	3.25	3.0	8.0	3.0	12
45MN/FN	0.85	2.10	2.80	4.00	4.0	11.0	4.0	20
55MN/FN	1.6	4.1	5.5	7.95	2.0	13.0	-	-

Unit : N

Block Type	ARC/HRC/ERC							
	Friction caused from ball bearing				Bottom Seals + Inner Seals	End Seals (2 sides)		External NBR seal with metal scraper
	Preload Class					S-Type Standard	B-Type Low friction	
VC	V0	V1	V2					
15MS/FS	0.30	0.60	0.80	1.00	1.5	2.0	0.5	4
20MS/FS	0.40	0.70	1.10	1.40	2.0	2.5	1.0	5
25MS/FS	0.50	0.90	1.20	1.80	2.5	3.0	1.5	8
30MS/FS	0.50	1.00	1.80	2.30	3.0	5.0	2.0	10

Unit : N

Block Type	ARC/HRC/ERC							
	Friction caused from ball bearing				Bottom Seals + Inner Seals	End Seals (2 sides)		External NBR seal with metal scraper
	Preload Class					S-Type Standard	B-Type Low friction	
VC	V0	V1	V2					
15ML/FL	0.40	0.70	0.90	1.40	1.5	2.0	0.5	4
20ML/FL	0.50	0.80	1.60	1.80	2.0	2.5	1.0	5
25ML/FL	0.70	1.20	1.80	2.00	2.5	3.0	1.5	8
30ML/FL	0.80	1.40	2.20	2.80	3.0	5.0	2.0	10
35ML/FL	0.90	1.60	2.70	3.50	3.0	8.0	3.0	12
45ML/FL	1.00	2.30	3.50	4.55	4.0	11.0	4.0	20
55ML/FL	1.9	4.3	6.6	8.6	2.0	13.0	-	-

Note: The end seal is made of elastic plastic material, not NBR, with low friction resistance and constant dynamic and static friction.

Applied example

- ARC25MN SZ V1N
Block friction = 1.6+2.5+3 = 7.1 N
- HRC30FL BZ V0P
Block friction = 1.4+3+2 = 6.4 N

Friction caused from ball bearing
Bottom Seals + Inner Seals
+ End Seals (2 sides)
Block friction

Product Design (Standard)

Saw wood dust Test

Test content

This test uses a total of 4 groups of products (2 rails matched with 2 lubrication methods) which are put on a saw wood dust surface on which a back and forth motion test is performed.

Rail

1. Standard rail plus hole plugs (AR)
2. Rail tapped from the bottom (ARU)

Runner Block

1. Installation of standard contact type seals (S), using grease.
2. Installation of lubrication storage Pad and standard contact type seals (SZ), using grease.

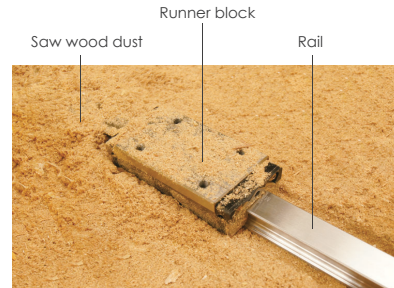

Testing conditions

1. Stroke = 600mm
2. Total testing stroke = 30m

Test items

1. If saw wood dust enters the inner surface of the runner block
2. If saw wood dust enters the ball bearing runner area

Test results

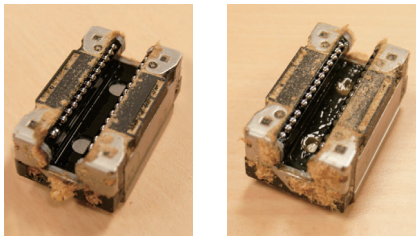

Tapped from bottom (oil) Tapped from bottom (grease)

Test result

- The standard rail has hole plugs, leading to rail unevenness, allowing some saw wood dust to enter the runner block belly area. The 2 sides of the runner block belly area are completely protected by stainless steel reinforcement plates and end seals, meaning that the ball bearing runner area is fully shielded from saw wood dust.
- The rail tapped from the bottom has an even rail surface so that the ball bearing runner area is fully protected from saw wood dust.

Checked Item	If saw wood dust enters inner block surface	If saw wood dust enters ball bearing runner area
Installation status		
ARU Rail SZ Type Runner Block (oil lubrication)	No	No
ARU Rail S Type Runner Block (grease lubrication)	No	No
AR Rail SZ Type Runner Block (oil lubrication)	Yes (belly area)	No
AR Rail S Type Runner Block (grease lubrication)	Yes (belly area)	No

Stainless steel reinforcement plate (Patent)

Scraping function on both sides

Using 2 stainless steel reinforcement plates, the L form design allows for screws to be fastened onto the top and bottom of the runner block, reinforcing the rigidity and cladding of its caps.

The clearance between the rail profile with the seal design is below 0.3mm, reinforcing the steel plates while enabling scraper functions.

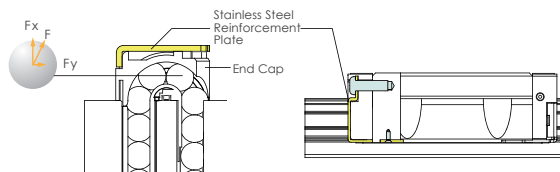

Function of high speed operation

Our ARC/HRC/ERC, ARD/HRD/ERD type features stainless steel reinforcement plates and additional bottom latches, increasing its axial force and tolerance capacity to achieve a faster operating speed.

$$V_{max} > 10 \text{ m/s} \quad a_{max} > 450 \text{ m/s}^2$$

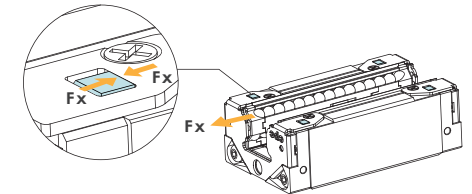

Multi-Directional Lubrication Nozzles (All-direction Lubrication Nozzles)

Our product features lubrication ports on the top, bottom, and sides, allowing the installation of optional grease nipples for relubrication. The top port comes with an O-ring seal to allow easy relubrication from the top, and our diverse comprehensive lubrication injection design allows for lubrication from all directions.



Instruction for side lubricant-nozzle-installation port of Linear Guide

The side lubrication injection port (see pic.1) on cpc's linear guide blocks is sealed on delivery to prevent leakage of lubricants.

Before installing lubricant injection nozzle or piping, the seal must be broken to allow lubricant to enter the runner block.

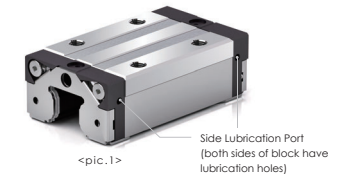

Installation Steps

1. Tool

To pierce the seal, select an awl with a diameter less than $\phi 1 \text{ mm}$ (see pic.2).

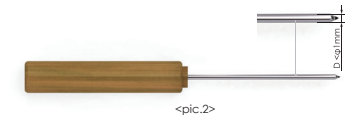

2. Side lubrication port

The seal is in a deeper small hole in the middle of the side lubrication injection hole on the block (see Detail View A from pic.3). The seal is only 0.2~0.3mm thick.

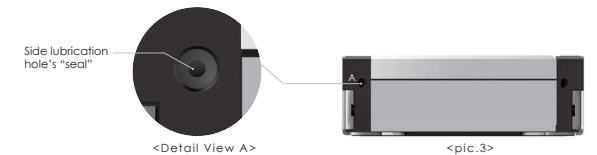

3. Piercing method

Use the awl to stab into the seal showed in above picture. Press the awl against the seal (see pic.4A) and move gently forward by about 1mm. Please do not use power tools or pierce too deep, to prevent damage to guide block end cap, which may impact its functionality and interfere with lubricant passage.

Sealed lubricant passage Cleared lubricant passage

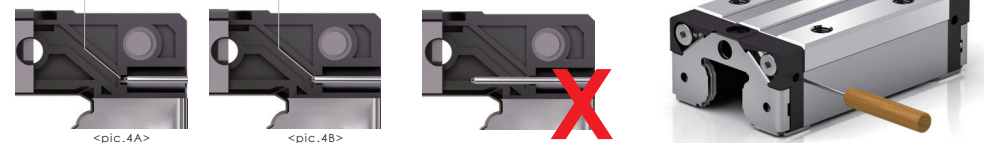

Product Design (Option)

Low noise, superior quality high speed ball chain (Patent)

Ordering code: C

With traditional ball type linear guides, the spinning of balls in different directions leads to a two-times faster contact speed. Such high friction greatly reduces the service life of such products. Additionally, the contact point between such balls also produces high pressure and noise levels while increasing the danger of oil film cladding damage.

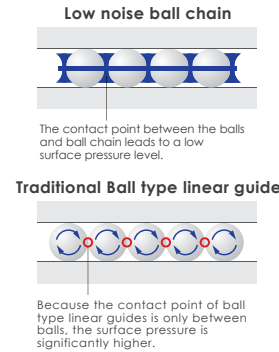
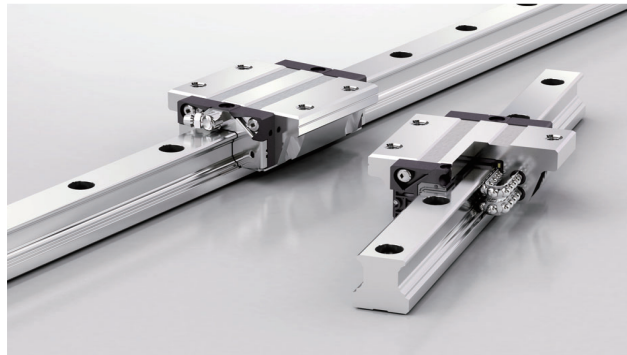

* The **cpc** ball chain provides a greater contact area between the balls and the ball chain. Because the film cladding will not be damaged easily and due to the lower noise volume, balls can move at a higher speed while product service life can also be extended significantly.

* The block with the ball chain design has the same dimensions as that without ball chains, allowing for the use of the same rails.

Heavy load test

Condition
 Model : ARC25MN SZC V1H Dynamic load rating C_{100} : 33.6kN
 Velocity : 1m/sec Stroke : 960mm
 Load capacities : 7.44kN(0.3C) Preload : 0.05C

$$\text{Rating Life} \left(\frac{C}{P} \right)^3 \times 100\text{km} = \left(\frac{C}{0.05C+0.3C} \right)^3 \times 100\text{km} = 2332\text{km}$$

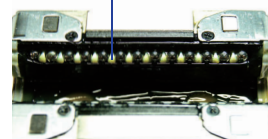
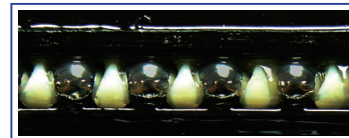

After testing, grease remains without anomalies.

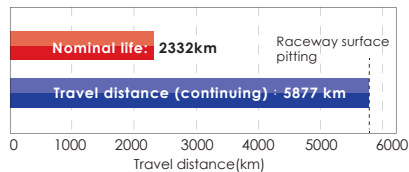

Smoothness test

Model code : ARC25MNSV1N
 Velocity : 10 mm/sec

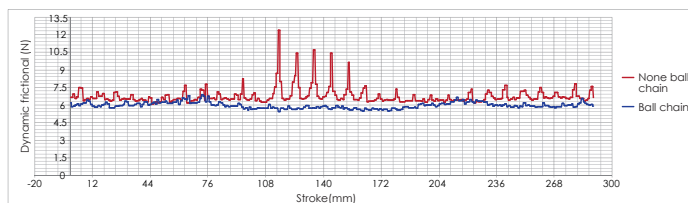

Load capacity of ball chain

There are three advantages of ARC/HRC/ERC/, ARD/HRD/ERD ball chain series as compared with traditional, non-ball chain blocks:

1. The space block in the ball chain can prevent the oil film from rupturing by ball to ball contact and decrease friction induced wear.
2. The retainer block of the ball chain can maintain a reliable oil film layer by continuously applying grease on the moving part.
3. The ball chain provides the important function of leading steel ball motion. For traditional blocks without ball chains, its steel balls are pushed by the rotating back steel balls on the raceway, meaning that the contact angle between the balls and rail is less precise, causing vibration and an increased stress level between balls. In comparison, the balls in our ball chain product are led by the ball chain to ensure a correct fit and accurate contact angles. In this way, our product's ball chain design ensures that it can fit correctly when entering the raceway and that the contact angle will be accurate. This means that our Ball chain design provides for a smooth performance, lower vibration levels and less additional stress levels. Subsequently increase the dynamic load rating, C_{cage} value.

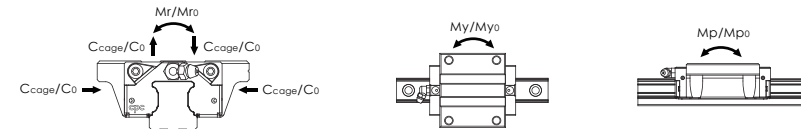

Dynamic rating load

The table on the right shows the C_{cage} and C_{iso} values via different machine type testing. (According to ISO-14728 regulations)

Model Code	C_{iso} (kN)	C_{cage} (kN)
ARC/ARD-MN C	15	9.4
ARC/ARD-FN C	20	15.4
HRC/HRD-MN C	25	22.4
HRC/HRD-FN C	30	31.0
ERC/ERD-MN C	35	43.7
	45	67.6
ARC/ARD-ML C	15	12.5
HRC/HRD-ML C	20	18.9
HRC/HRD-FL C	25	28.5
ERC/ERD-ML C	30	38.0
	35	50.6
	45	86.2
ARC/ARD-MS C	15	7.1
ARC/ARD-FS C	20	11.6
ERC/ERD-MS C	25	16.8
	30	21.3

Static rating load & Static torque

The C type block of ARC/HRC/ERC/, ARD/HRD/ERD will increase the pitch between balls on the operating profile. Therefore, the static rating load C_0 and the static rating torque M_{r0} , M_{p0} and M_{y0} values will be decreased.

Model Code	Static rating load(kN)		Static torque(Nm)		
	C_0	M_{r0}	M_{p0}	M_{y0}	
ARC/ARD-MN C	15	16.2	130	95	95
ARC/ARD-FN C	20	25.7	275	200	200
HRC/HRD-MN C	25	36.4	465	340	340
HRC/HRD-FN C	30	49.6	780	530	530
ERC/ERD-MN C	35	70.2	1575	1010	1010
	45	102.8	2955	1775	1775
ARC/ARD-ML C	15	24.3	195	215	215
HRC/HRD-ML C	20	34.3	370	350	350
HRC/HRD-FL C	25	51.6	655	640	640
ERC/ERD-ML C	30	66.1	1040	900	900
	35	94.7	1940	1575	1575
	45	159.7	4185	3280	3280
ARC/ARD-MS C	15	10.8	85	45	45
ARC/ARD-FS C	20	17.1	185	85	85
ERC/ERD-MS C	25	24.3	310	145	145
	30	28.9	455	205	205

Product Design (option)

Lubrication Design

(Ordering Code: Z) (ARC/HRC/ERC, ARD/HRD/ERD)

Inner oil storage and oil supply system design

Our Inner PU Lubrication Storage Pad design does not increase the length of the runner block and can effectively lubricate all balls. Customers can inject lubrication oil directly through its lubrication holes to ensure sufficient storage in the PU Lubrication storage pad. This not only enables long-term lubrication effects but also a higher degree of ease at conforming to environment protection needs and lowering maintenance costs. For short-stroke movements, this product allows for highly effective lubrication.

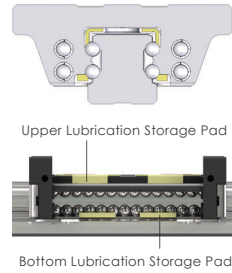

Extending the relubrication interval and reducing the amount of lubricant has always been the main issues for the manufacturers of linear guides. The rolling elements and the raceway surface must be completely lubricated. This is the condition that the linear guide must have to operate. However, the application environment of linear guides is quite different. A critical environment due to acid, iron filings, wood chips, coolant, working speed, stroke length, load, installation, etc. will affect lubrication. The **cpc** lubrication storage can keep oil/grease for a long time. **cpc** block with the lubrication unit can be used in the same way as the block without an oil tank. The grease nipple can be mounted on the block and the lubricant can be supplied directly and achieves the effect of permanent lubrication!

External NBR Seal with Metal Scraper (Ordering Code: SN / HN)

(ARC/HRC/ERC, WRC, ARD/HRD/ERD, ARR/HRR/LRR)

Available for applications in harsh environments such as in grinding, glass processing, graphite processing and wood-working machinery, providing a highly effective dust and iron scrap proofing solution.

SN: (made by BRB) For application in harsh environment.

HN: (made by HNBR) For application of resisting acidic / basic coolant.

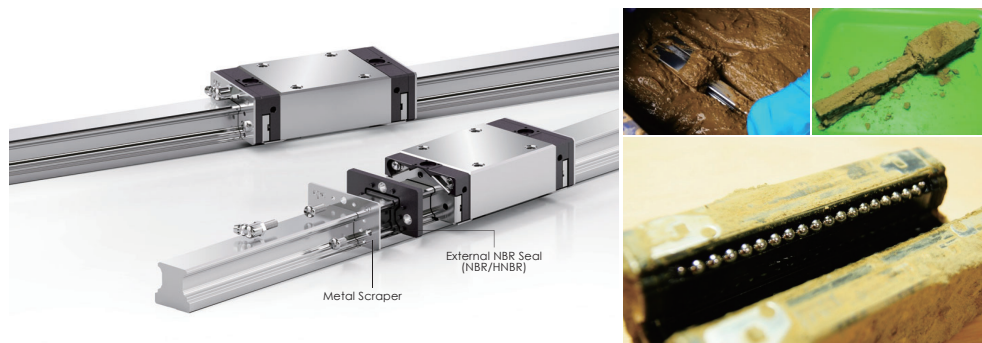

Installation Manual

- When installing the external NBR seal, please ensure that the block is on the rail.
- Ensure that the rubber part is fitted in the sleeve. If the rubber part has fallen off, set the sleeve to the corresponding bore.
- Overlap the rubber part and metal scraper with the corresponding salient point and bore. The **cpc** logo must be facing outward.
- Slide the external NBR seal into the rail from two sides and closely connect with the block.
- Fasten the screw into the correspondence bore and align the seal with the center of the rail and properly fastened. Do not allow the metal scraper to make contact with the guide rail.

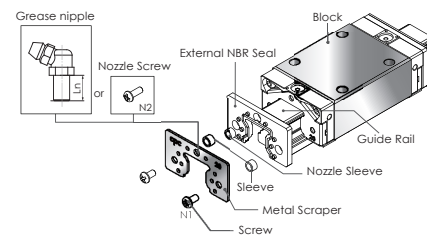

ARC/HRC/ERC ball type external NBR seal dimensions and specifications

Dimensions of the block mounted with external NBR seals

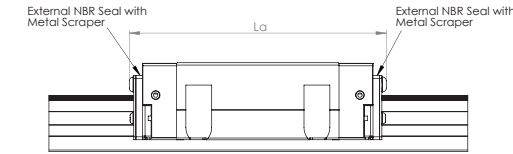

Model Code	Exterior Dimension La			Unit: mm
	MS/FS	MN/FN	ML/FL	
ARC/HRC/ERC				
15	54.2	68.5	98.2	
20	62.2	82	100.2	
25	75.8	99.6	123.4	
30	88	115.5	138	
35	-	131.2	156.6	
45	-	157.5	193.5	
55	-	188.5	222	
WRC				
27/20	-	83	-	

The size and position of the screw hole on the stainless steel reinforcement plate

Functions of the screw hole on the stainless steel reinforcement plate:

- using for external NBR seal
- using for the bellow
- using for MSS reader

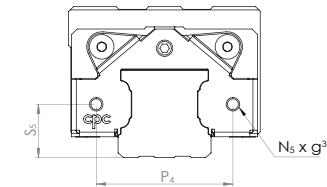

Model Code	Exterior Dimension				Unit: mm
	P4	S5	N5	g ³	
ARC/HRC/ERC					
15	25	9.4	M3x0.35	2.3	
20	29	12.5	M3x0.35	2.1	
25	36.5	14.5	M3x0.35	2.8	
30	42.5	17	M4x0.5	3.2	
35	50	19.5	M4x0.5	3.1	
45	65	24	M4x0.5	5.8	
55	73	28.5	M5x0.5	5.6	
WRC					
27/20	50	11	M3x0.35	2.5	

Dimensions of external NBR seals

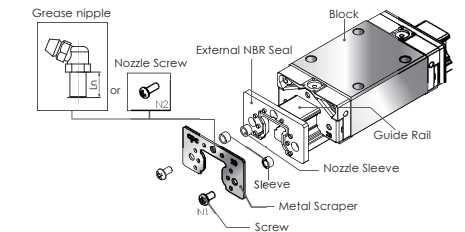
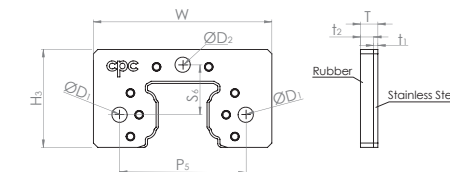

Model Code	Exterior Dimension						Bore Specification		Screw Specification			Nipple	
	T	t1	t2	W	Hb	P5	S5	ØD1	ØD2	N1	N2		Ln
ARC/HRC/ERC													
15	4	1	3	33	20.3	25	10.2	3.5	3.5	M3x0.35	M3x0.5	9	A/B-M3-L
20	4	1	3	41	22.5	29	11.5	3.5	3.5	M3x0.35	M3x0.5	9	A/B-M3-L
25	5.2	1.2	4	47	26.5	36.5	13.5	3.5	6.5	M3x0.35	M6x0.75	12	A/B-M6-L
30	6	1.5	4.5	58	34.2	42.5	17.5	4.5	6.5	M4x0.5	M6x0.75	12	A/B-M6-L
35	6	1.5	4.5	68	39.3	50	20.5	4.5	6.5	M4x0.5	M6x0.75	12	A/B-M6-L
45	6	1.5	4.5	84	49.6	65	24.9	4.5	10	M4x0.5	PT1/8	15	B-PT1/8-L
55	6	1.5	4.5	98	57	73	28	5.5	6.5	M5x0.5	M6x0.75	12	A/B-M6-L
WRC													
27/20	4	1	3	61	23.2	50	11.5	3.5	3.5	M3x0.35	M3x0.5	9	A/B-M3-L

ARR/HRR/LEE roller type external NBR seal dimensions and specifications

Dimensions of the block mounted with external NBR seals

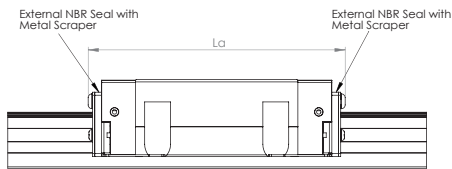

Unit: mm

Model Code	Exterior Dimension La		
	MN/FN	ML/FL	MXL/FXL
35	142	167.5	197.5
45	176	211	246

The size and position of the screw hole on the stainless steel reinforcement plate

Functions of the screw hole on the stainless steel reinforcement plate:

1. using for external NBR seal
2. using for the bellow
3. using for MSS reader

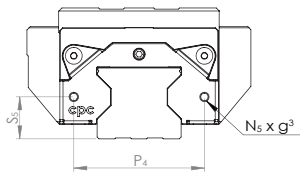

Unit: mm

Model Code	Exterior Dimension			
	P ₄	S ₅	N ₅	g ³
15	26	9.6	M3x0.35	1.4
20	29	12.5	M3x0.35	1.4
25	36.5	14	M3x0.35	1.7
35	60	18	M4x0.5	4.7
45	70	22.5	M4x0.5	3.3
55	76	27	M4x0.5	3.5

Dimensions of external NBR seals

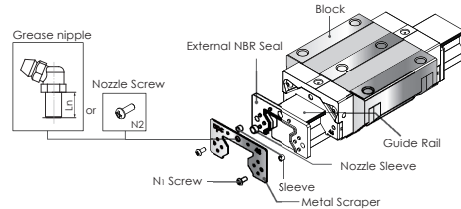
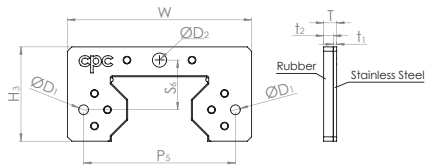

Unit: mm

Model Code	Exterior Dimension						Bore Specification				Screw Specification			Nipple
	T	f ₁	f ₂	W	H _s	P ₅	S ₁	S ₂	ØD ₁	ØD ₂	N ₁	N ₂	Ln	
35	6	1.5	4.5	69	37.6	60	60	20	4.5	6.5	M4x0.5	M6x0.75	16	A/B-M6-XL
45	6	1.5	4.5	84.9	43.5	70	70	22.9	4.5	6.5	M4x0.5	M6x0.75	16	A/B-M6-XL

Metal-Plastic-Cap Patent Design for Standard Rail-Bolt-Hole (With patent) (Ordering Code: MPC)

Metal Cap Features Introduction

The Most Convenient Metal Cap Used in Industry

- The upper part of the cap is made of stainless steel which can prevent sharp foreign objects from piling up on the bolt-hole and affect the end seal function.
- The lower part of the cap is made of plastic, and can be installed directly on a standard rail without the need for additional bolt-hole slot milling.
- The bolt-hole chamfer for standard rails is C0.2mm. For further dustproof requests, the non-bolt-hole chamfer rail is optional upon ordering. (order code: TR)

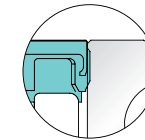

Bolt-Hole with Chamfer (standard)

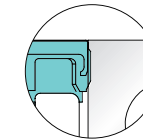

Bolt-Hole without Chamfer (optional: /TR)

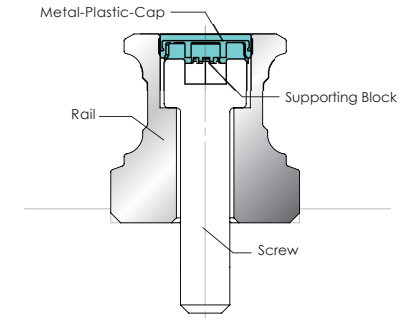

Cap can be Smoothly Installed on Bolt-Hole

Bolt-hole cap of conventional linear guides, due to the difficulty of controlling hammering strength, often result in caps being hammered too deep or surface unevenness which leads to the accumulation of dirt or scrap iron. Our **cap** is especially designed with a supporting block to prop up the cap and to fix the screw stably, thus preventing such unnecessary sinking.

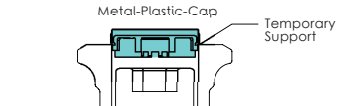

Cap before Hammering (Plastic Support)



Plastic Support after Hammering (The form of the 8 supporting blocks will become altered to fit with the screw)

Dimensions and Specifications

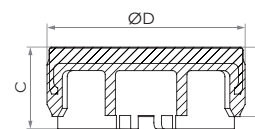

Model Code	Screw	External Diameter D	Cup Height H	Block Height C	Rail
A4	M4	7.7	1.7	2.0	AR15, WRC21/15, WRC27/20, ARR15
A5	M5	9.7	3.4	4.0	AR20, ARR20
A6	M6	11.3	2.9	3.5	AR25, ARR25
A8	M8	14.3	3.9	4.5	AR30, ARR35
A12	M12	20.4	5.0	5.6	AR45, ARR45
A8-R	M8	14.3	8.0	9.5	ARR35
A14	M14	24.4	6.0	6.5	AR55, ARR55

Technical Information

Load capacity and service life

Basic static load capacity C_0

The static load along the direction of the force; under this static load, the maximum calculated stress at the center point of the contact surface between the ball and the track:

The value is 4200 MPa when radius of curvature ratio = 0.52
The value is 4600MPa when the radius of curvature = 0.6

Roller and rail contact surface produces the maximum calculated stress:
The value is 4000MPa

cpc's design of the roller guide series products has optimized the contact surface between the roller and the raceway of the rail. The line contact stress is evenly distributed. There is no edge stress effect, so they can withstand greater stress, as shown in the right picture.

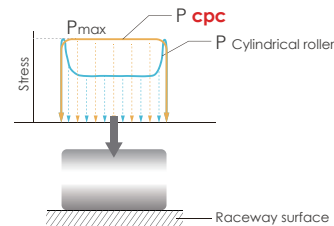

Note: At this point of maximum stress contact will yield a permanent deformation, which corresponds to 0.0001 diameter of the rolling element. (Above according to ISO 14728-2)

Static load safety factor calculation

- (1) $S_0 = C_0 / P_0$
- (2) $S_0 = M_0 / M$
- (3) $P_0 = F_{max}$
- (4) $M_0 = M_{max}$

Operating situation	S_0
General operation	1~2
Shock or impact	2~3
High precision and smooth operation	≥ 3

Equivalent static load P_0 and basic static torque M_0

The application of the static load capacity of the linear guide series must be considered:

- Static load of linear guide
- Allowable load of screw fixation
- Permissible load of connected bodies
- The required static load safety factor for the application

The equivalent static load and static torque are the maximum load and torque values, refer to equations (3) and (4).

Static load safety factor S_0

In order to be able to withstand the permanent deformation of the linear bearing and ensure that it will not affect the accuracy and smooth operation of the linear slide system. The static load safety factor S_0 is calculated as equations (1) and (2).

- S_0 Static load safety factor
- C_0 Basic static load N in direction of load
- P_0 Equivalent static load N in direction of load
- M_0 Basic static torque Nm in direction of load
- M Equivalent static torque Nm in direction of load

When the block alone experiences the torque

If the block alone experiences the torque from M_p and M_y direction, the maximum allowable torque for the block to run smoothly is 0.2 to 0.3 times static torque. And the block with larger preload would have larger maximum allowable torque and vice versa. When static torque M_p and M_y is larger than maximum allowable torque, the jumping of the block will be caused when the ball is rolling through the loaded / unloaded region in the block. If you have above mentioned design problem, please contact our technical department.

Basic dynamic load capacity C_{iso} (general design) / C_{cage} (ball chain design)

$$C_{iso} : C_{100} / C_{50}$$

Definition: C_{100} is a radial load with constant magnitude and direction; when the linear bearing is subjected to this load, its rated life can theoretically reach a walking distance of 100 kilometers, and C_{50} is a walking distance of 50 kilometers. (Above according to ISO 14728-1)

According to ISO 14728-1 for the bearing steel used in the current technology, the calculated life span of 90% survival rate for a single or batch of sufficient and identical linear bearings under normal manufacturing quality and normal operating conditions is as follows:

$$(5) \quad L = \left[\frac{C_{100}}{P} \right]^{\alpha} \cdot 10^5$$

$$L = \left[\frac{C_{50}}{P} \right]^{\alpha} \cdot 5 \times 10^4$$

L = rated life

C_{100}/C_{50} = Dynamic Load Rating (N)

P = equivalent load (N)

When using a ball type linear guide $\alpha = 3$

When using roller linear guide $\alpha = \frac{10}{3}$

Please refer to equations (6) and (7) for a comparison of the basic rated load capacity defined by the two types of basic load capacity conversion when the standard rated load capacity C_{50} is taken as the standard when the 50 km distance is taken as the rated life. (according to ISO14728-1)

Ball

$$(6) \quad C_{50} = 1.26 \cdot C_{100}$$

$$(7) \quad C_{100} = 0.79 \cdot C_{50}$$

C_{cage} is a basic dynamic load capacity value of block with ball chain, which is 120 to 130% of the C_{iso} value according to the practical test (see Page 8). Formulas (5), (6), and (7) also apply to $C_{100/cage}$ and $C_{50/cage}$

According to the operating velocity and frequency, the service distance can be converted to service life, assuming the equivalent load and average velocity are constant.

$$(8) \quad L_h = \frac{L}{2 \cdot s \cdot n \cdot 60} = \frac{L}{v_m \cdot 60}$$

L_h = Rated life (h)

L = Rated life for walking 100 km (m)

s = Single stroke (m)

n = Frequency of reciprocating stroke (min^{-1})

v_m = Average velocity (m/min)

Technical Information

Load capacity and life

Equivalent load and Velocity

When the load and velocity are not constant, all actual loads and velocities must be considered, and it will impact the service life.

For each segment of each block, when the load changes, the equivalent load is calculated according to formula (9).

$$(9) \quad P = \sqrt[\alpha]{\frac{q_1 \cdot F_1^\alpha + q_2 \cdot F_2^\alpha + \dots + q_n \cdot F_n^\alpha}{100}}$$

P = equivalent load (N)

When using ball-type linear guide $\alpha = 3$

When using roller-type linear guide $\alpha = \frac{10}{3}$

q = portion of working distance per segment (%)

F₁ = load per segment (N)

When the velocity changes, the equivalent velocity is calculated according to formula (10).

$$(10) \quad \bar{v} = \frac{q_1 \cdot v_1 + q_2 \cdot v_2 + \dots + q_n \cdot v_n}{100}$$

\bar{v} = equivalent velocity (m/min)

q = portion of working distance per segment (%)

When the load and velocity all change, the equivalent load is calculated according to formula (11).

$$(11) \quad P = \sqrt[\alpha]{\frac{q_1 \cdot v_1 \cdot F_1^\alpha + q_2 \cdot v_2 \cdot F_2^\alpha + \dots + q_n \cdot v_n \cdot F_n^\alpha}{100 \bar{v}}}$$

P = equivalent load (N)

When using ball-type linear guide $\alpha = 3$

When using roller-type linear guide $\alpha = \frac{10}{3}$

q = percentage of walking distance per segment (%)

v = velocity of each segment (m/min)

F₁ = load per segment (N)

When the linear guide is subjected to any angular load and the direction of the force other than the horizontal or vertical direction, the approximated value of equivalent load is calculated as (12).

$$(12) \quad P = |F_x| + |F_y|$$

P = equivalent load (N)

F_x = force at horizontal component (N)

F_y = force at vertical component (N)

When the linear guide experience both load and torque at the time, the approximated value of equivalent load is calculated by formula (13)

$$(13) \quad P = |F| + |M| \cdot \frac{C_0}{M_0}$$

P = equivalent load (N)

F = load applied to the LM guide (N)

M = static torque (Nm)

C₀ = basic static load direction (N)

M₀ = basic static torque in direction of force (Nm)

Operating temperature range

-40 °C ~ 80 °C

The Linear Guide Series have a permissible operating temperature between -40 °C and 80 °C, and the maximum temperature for short-term operation can reach +100 °C.

Friction

The linear guides have stable and constant running friction and slight start-up friction, which brings out the properties of the product's low frictional resistance to the full.

Friction

$$F_{rm} = \mu \cdot F$$

F_m = Friction (N)

F = Load (N)

The Rller Guide Series friction factor is approx. $\mu=0.001\sim0.002$

Friction Factors

- Sealing system
- Collision between rolling elements and rolling elements during operation
- Collision of the rolling elements with the return path
- Resistance caused by the rolling and sliding phenomenon at the contact point of the rolling element and the raceway of the rail
- Resistance caused by the squeezing of lubricant when the rolling elements running
- Resistance caused by contaminations

In general, the loads on the linear guide exert on the four major planes. However it can be the load from any angle. In this case, the life of the linear guide is reduced. This can be interpreted by the flow of forces inside the system.

Line chart

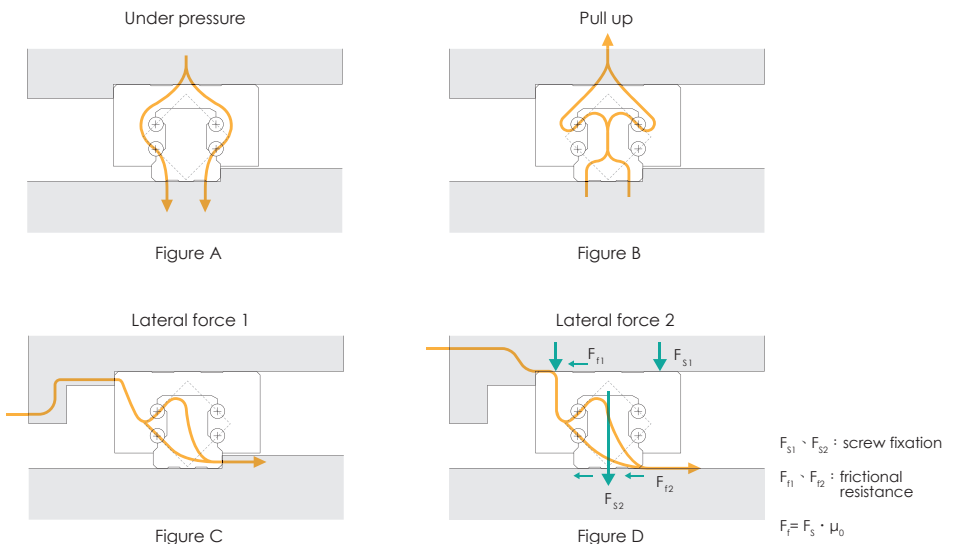

As can be seen from the three diagrams in Figure A to Figure D, when subjected to upward, downward and lateral loads, the force flow will be distributed to the two ball transfer.

Technical Information

Load capacity and life

Line chart

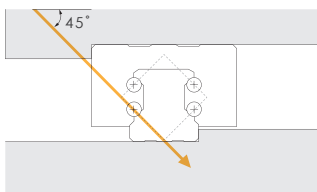

Figure E

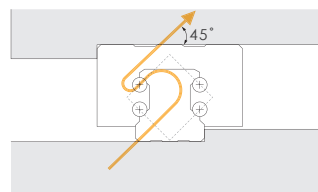

Figure F

As shown in the two diagrams in Figures E and F, the load acting on the 45-degree angle has the greatest effect on the system's life because the transfer of force is limited to a single row of balls.

When the load is applied horizontally or vertically (0°, 90°, 180°, 270°), the equivalent load of the slide is equal to the actual load. When the load angle is 45°, its equivalent load is approximately 1.414 times that of the main direction. (as shown in formula (12))

When the same load is at different angles, the comparison of equation (12) and the actual equivalence load is as shown in the following figure.

Therefore, in order to increase the service life of the linear system, it should be installed in the appropriate direction to bear the load. Otherwise, the service life will be greatly reduced, as shown in the figure below. Since the relationship between life and load is as the power of formula (5), when the acceptance angle is 45°, the service life will be significantly reduced.

The following is the life L comparison chart (in %) for different angles under the same load.

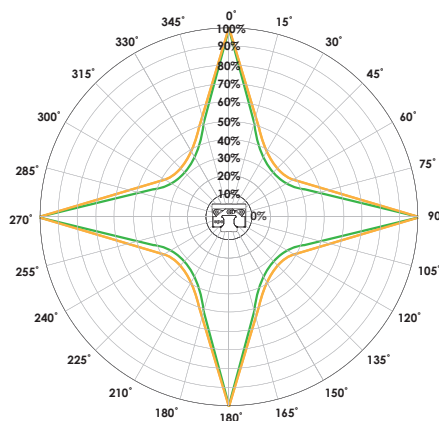
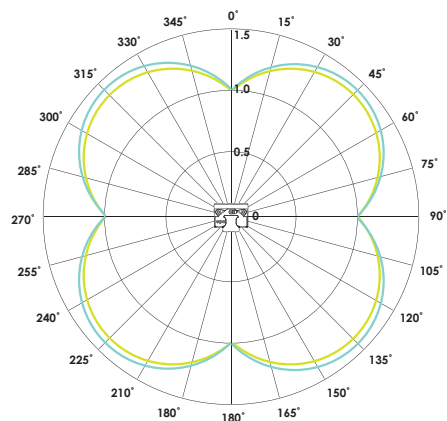

— Equation (12) (Page 15) calculates the approximate value of the equivalent load — Actual equivalence load

— Ball — Roller

The following is a comparison diagram of the equivalent load approximate value and the actual equivalent load calculated by Equation (13). The example uses the ARC25MN linear guide to withstand a fixed down pressure and the torque gradually increases. The above figure shows the torque in the Mr direction. The figure below shows the torque in the M_{py} direction.

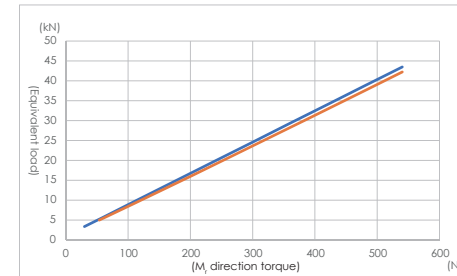

— Equation (13) (Page 15) Calculate the approximate value of the equivalent load $|\frac{M}{M_{to}}| \cdot C_0$
— Actual equivalence load

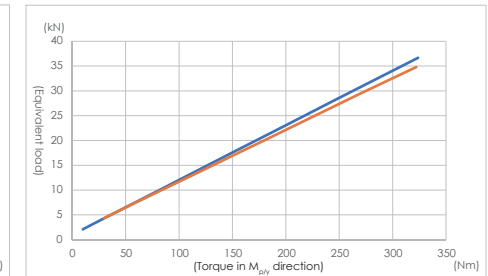

— Equation (13) (Page 15) calculates the approximate value of the equivalent load $|\frac{M_{py}}{M_{py0}}| \cdot C_0$
— Actual equivalence load

Load calculation

1. The load exert on the linear guide would varies due to the position of object's center of gravity, thrust position and acceleration / deceleration induced inertia.
2. Because of the uneven distribution of force on linear guide, when a certain part of rail, or when a force exertion point is damaged, the linear guide system would start to malfunction.
3. The point with largest force exertion must be identified, and be used reference to calculate the equivalent load, to ensure the reliability of service life calculation.

Ball

$$Q \propto F (Dw^{\frac{1}{2}}, \delta^{\frac{3}{2}}, C_0^{\frac{3}{2}})$$

Q = load
 δ = amount of rolling element deformation
 Dw = ball diameter
 C_0 = geometric constant

Roller

$$Q \propto F (\delta^{\alpha}, \ell_{eff}^{\beta})$$

Q = load
 δ = amount of rolling element deformation
 ℓ_{eff} = contact length

As shown by the formula, the relationship between the amount of deformation of the rolling element and load is not linear. A larger deformation will cause the non-linear increase of load.

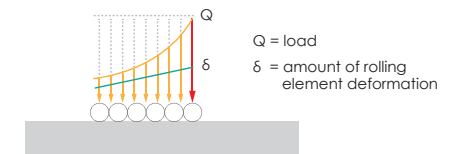

Therefore by using the **cpc** self-developed program, the "Loading, Lifetime, & Rigidity Analysis Software of Linear Guide System (LLRAS)", a precise service life estimation can be derived. This is done by optimum calculation of deformation and rotation when a linear guide experience load, in this case the accurate equivalent load can be calculated.

Technical Information

Loading, Lifetime, & Rigidity Analysis Software of Linear Guide System (LLRAS) Data input guidance

1. Set the slide rail position, the number of slides on the slide

LLRAS Loading Lifetime & Rigidity Analyzer System

Rail setting

Rail ID	X coord (mm)	Z coord (mm)	Rotation angle (°)	Block No.
Rail 1	0	0	0	12
Rail 2	200	0	0	12

Base coord

- X axis: Movement direction on the horizontal plane
- Y axis: The axis perpendicular to X axis on the same horizontal plane
- Z axis: The axis perpendicular to the horizontal plane

System coord

- X axis: The direction of block movement
- Y axis: Rail span direction
- Z axis: The axis perpendicular to xy plane

- Variables can be set:
- Linear guide span
 - Linear guide height
 - Linear guide placement angle
 - Platform inclination
 - Number of block

3. Set the exercise state

LLRAS Loading Lifetime & Rigidity Analyzer System

Movement status

ID	Start	Interval	Vel(m/s)	acc(m/s ²)	Rel	Count
Interval 1	0	0.5	0	0.500	0	100000
Interval 2	0.5	0.5	1.000	0.000	0	100
Interval 3	1.0	0.5	0	0.500	0	100000

V-T Drawing

Number of exercise intervals: 3

Total Time: 1.500 Total Stroke: 1000.000

Drive position Y Coord (mm): 0.000 Acting frequency (Hz): 0.000

Drive position Z Coord (mm): 0.000 Daily operating hours: 0.000

- Variables can be set:
- Working status
 - Drive position
 - Actuation frequency

2. Set the carriage size model

LLRAS Loading Lifetime & Rigidity Analyzer System

Block setting

Rail ID	Block ID	X coord (mm)	Block Model	Size	Model code	Preload
Rail 1	Block 1	0	ARC	25	ARC25098	VC
Rail 1	Block 2	200	ARC	25	ARC25098	VC
Rail 2	Block 1	0	ARC	25	ARC25098	VC
Rail 2	Block 2	200	ARC	25	ARC25098	VC

Preload Table

Class	Description	Preload (N/mm)	15	20	25	30	35	40	50
VC	Clearance	0	15-10	15-10	15-10	15-10	15-10	15-10	15-10
VD	Light Preload	0.020	10-4	10-5	10-4	10-7	10-4	10-10	10-12
V1	Medium Preload	0.050	4-10	6-12	6-15	7-18	8-20	10-24	12-28
V2	Heavy Preload	0.080	10-16	12-18	15-23	18-27	20-31	24-36	28-44

- Variables can be set:
- Block span
 - Block type
 - Block preload

4. Set external force and torque position, size, direction

LLRAS Loading Lifetime & Rigidity Analyzer System

Force and torsion resistance

X coord (mm)	Y coord (mm)	Z coord (mm)	Fx(N)	Fy(N)	Fz(N)	Torx (N·m)	Tory (N·m)	Torz (N·m)
100	100	0	0	0	0	0	0	0

Check the force and torque included in each interval

Interval	Position	Direction
Interval 1	0.000	0.000
Interval 2	0.000	0.000
Interval 3	0.000	0.000

- Variables can be set:
- External force (torque) intensity
 - External force (torque) position
 - External force (torque) working zone

Technical Information

Loading, Lifetime, & Rigidity Analysis Software of Linear Guide System (LLRAS)

5. Set the quality position size

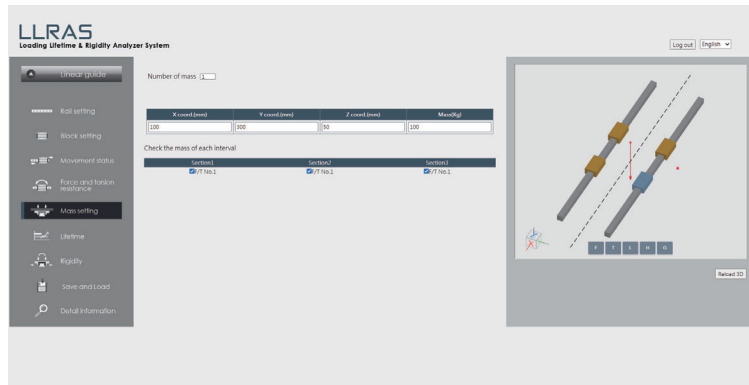

- Variables can be set:
- Center of gravity position
 - Center of gravity dimension
 - Load range

6. Check if the settings are correct from the 3D chart

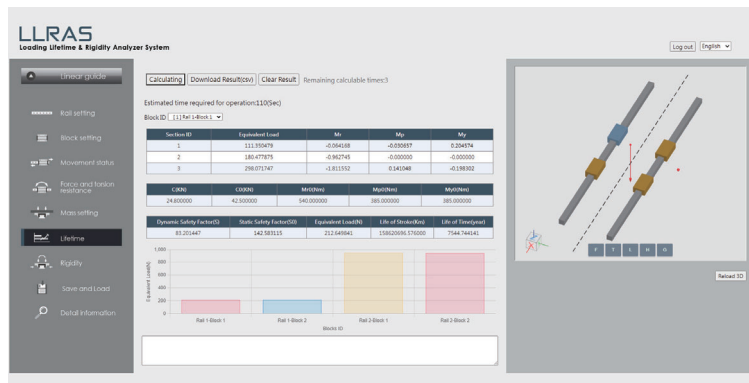

The calculation results are shown in the figure, and the information such as force and equivalent load, safety factor, and life span of each section can be obtained, and the deformation of any measured point can also be obtained.*

This program can be used to calculate the installation and dimension design of various linear slide rails under different load and movement conditions. The obtained information such as deformation amount, force distribution, and life span can help to provide appropriate and correct design recommendations.

* For the calculation of amount of deformation, only the rolling object is considered. For actual deformation the steel body of block must be considered as well. When the load > 20% C0, the actual deformation is 1.5 times larger than calculated deformation. When Load = C0, the actual deformation is 2~2.5 times of calculated deformation.

Application Example

Using the ARC 25 MN VC block, the schematic diagram of the mechanism is as follows:

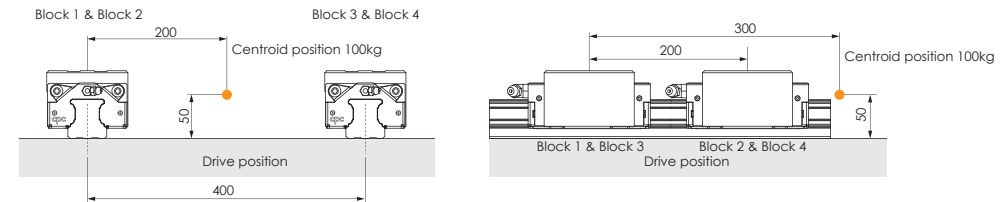

Motion status is as follows

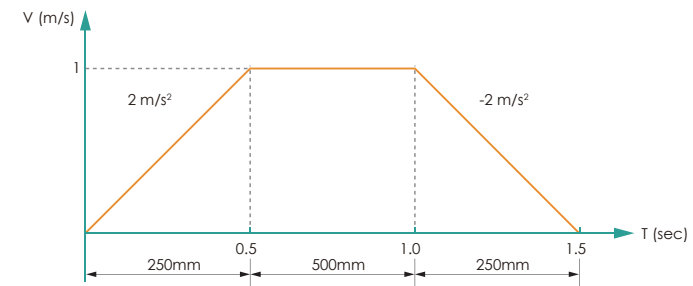

cpc

	Unit:N			
	Block 1	Block 2	Block 3	Block 4
At acceleration	348.6	914.5	348.6	914.5
At constant velocity	384.0	949.9	384.0	949.9
At deceleration	419.4	985.3	419.4	985.3
Average load	385.9	951.0	385.9	951.0

Traditional calculated results obtained by geometric distribution.

	Unit:N			
	Block 1	Block 2	Block 3	Block 4
At acceleration	220	711	220	711
At constant velocity	245	736	245	736
At deceleration	270	761	270	761
The maximum value of average load	736			

Results calculated by program

In this case, the calculated result of equivalent load is 30% higher than result obtained by traditional geometric distribution method, and the service life is about 2 times different.

If there is a demand for life and rigidity calculation, please fill in form of [Linear guide service life calculation and model selection] and contact cpc technical department.

Technical Information

The maximum bearing capacity of linear guide is not only related to the static load capacity C_0 , but also the screw mounting of coupling parts. Factors such as length of block, distance between rails, size of screws, and contact width of rail would impact the maximum bearing capacity of screw mounting.

Screw tightening torque (Nm)

Strength grade 12.9 Alloy steel screws	steel		cast iron		Non-ferrous metals	
	M	Torque (Nm)	M	Torque (Nm)	M	Torque (Nm)
M3	2.0	1.3	1.0			
M4	4.1	2.7	2.1			
M5	8.8	5.9	4.4			
M6	13.7	9.2	6.9			
M8	30	20	15			
M10	68	45	33			
M12	118	78	59			
M14	157	105	78			

The lateral bearing capacity (without support from edge and lateral mounting)

Linear guide often experience lateral load when used; in the case of mounting screw only, the lateral bearing capacity is suggested to be determined by the static friction force resulted from the screw tightening torque. If the maximum lateral load is exceeded, the support from the edge, lateral mounting and plugs are possible options to enhance the load capacity.

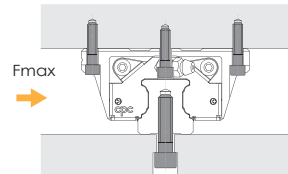

According to DIN637, DIN SIO 12090-1 and DIN EN ISO 898-1 regulation, when the tensile strength, torque and lateral force exert on class 8.8 alloy steel screw is larger than the values in table below, the screw mounting and design of edge support must be revised to avoid loose.

Screw maximum tensile strength and torque

size	ball type						roller type					
	short		standard		long		standard		long			
	$F_{z,max}$ N	$M_{t,max}$ Nm	$F_{z,max}$ N	$M_{t,max}$ Nm	$F_{z,max}$ N	$M_{t,max}$ Nm	$F_{z,max}$ N	$M_{t,max}$ Nm	$F_{z,max}$ N	$M_{t,max}$ Nm		
15	3200	22	3700	26	4200	30	7200	50	8000	60		
20	5500	51	6400	60	7300	68	12500	115	14500	134		
25	8100	87	9400	100	10800	120	18700	190	21000	240		
30	15900	210	18500	240	21100	280	36900	470	42200	560		
35	-	-	18500	300	21100	340	36900	590	42200	680		
45	-	-	45900	970	52400	1100	91700	1900	104800	2200		
55	-	-	63700	1600	72800	1800	127400	3200	145600	3600		

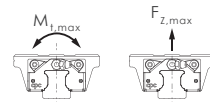

Screw lateral bearing capacity

size	ball type			roller type	
	short	standard	long	standard	long
	$F_{y,max}$ N	$F_{y,max}$ N	$F_{y,max}$ N	$F_{y,max}$ N	$F_{y,max}$ N
15	240	280	320	550	630
20	410	480	550	950	1050
25	610	710	810	1400	1600
30	1200	1400	1600	2800	3200
35	-	1400	1600	2800	3200
45	-	3400	3900	6900	7900
55	-	4800	5500	9600	11000



When class 10.9 class alloy steel screw is used, the value is about 1.4 times larger than the value in table above. When 12.9 class alloy steel screw is used, the value is about 1.68 times larger.

Lateral bearing surfaces and lateral fixing elements

When the lateral load is greater than the lateral load capacity, the lateral bearing surface is required to bear the lateral force. If the lateral force is bidirectional, lateral fixing elements can be used to provide a bidirectional lateral load capability of the linear guide on the other side of the side bearing surface, and help close to the lateral bearing surface, the lateral straightness and side load capacity after installation will be greatly improved, and its allowable value will vary according to the type of fixed component.

The following diagram shows several common elements.

Wedge block

Lateral bearing surfaces

Wedge block

Wedge block

The linear guide rail is tightened by locking the bolts on the wedge block.

Binder plate

Open slot

Binder plate

The open slot must be machined to prevent interference between the linear guide and carriage on the corners during installation.

Socket set screws

Socket set screws

When the installation space is limited, the size of lateral mounting element must be considered.

Mandrel fixing

Mandrel

Use the slope of the nut to advance the roller to achieve the effect of tightening the linear LM guide.

Technical Information

Preload and clearance

The ARC/HRC/ERC, ARD/HRD/ERD linear guides provide 4 different preload classes VC, V0, V1, V2.

ARC/ARD/WRC										
Class	Description	Preload Value	Clearance (μm)							Application
			15 WRC21/15	20 WRC27/20	25	30	35	45	55	
VC	Clearance	0	+5~+0	+5~+0	+5~+0	+5~+0	+5~+0	+5~+0	+5~+0	Smooth motion, low friction
V0	Light Preload	0.02C	+0~-4	+0~-5	+0~-6	+0~-7	+0~-8	+0~-10	+0~-12	For precision situations, smooth motion
V1	Medium Preload	0.05C	-4~-10	-5~-12	-6~-15	-7~-18	-8~-20	-10~-24	-12~-28	High stiffness, precision, high load situations
V2	Heavy Preload	0.08C	-10~-16	-12~-18	-15~-23	-18~-27	-20~-31	-24~-36	-28~-45	Super high stiffness, precision and load capacity

HRC/ERC/HRD/ERD										
Class	Description	Preload Value	Clearance (μm)							Application
			15	20	25	30	35	45	55	
VC	Clearance	0	+5~+0	+5~+0	+5~+0	+5~+0	+5~+0	+5~+0	+5~+0	Smooth motion, low friction
V0	Light Preload	0.02C	+0~-4	+0~-5	+0~-6	+0~-7	+0~-8	+0~-10	+0~-12	For precision situations, smooth motion
V1	Medium Preload	0.08C	-4~-12	-5~-14	-6~-16	-7~-19	-8~-22	-10~-25	-12~-29	High stiffness, precision, high load situations
V2	Heavy Preload	0.13C	-12~-19	-14~-23	-16~-26	-19~-31	-22~-35	-25~-40	-29~-46	Super high stiffness, precision and load capacity

Operating Temperature

The Linear Guide Series of standard ball guide, wide ball guide and roller guides have a permissible operating temperature between -40 °C and 80 °C, and the maximum temperature for short-term operation can reach + 100 °C.

Installation Notice

Dimension of reference edge

To ensure that the linear guide is precisely assembled with the machine table, **cpc** devices have a recess installed in the reference edge corner. The corner of the machine table must be smaller than the chamfer of the linear guide to avoid interference. To consult on chamfer sizes and shoulder heights, please refer to the table below.

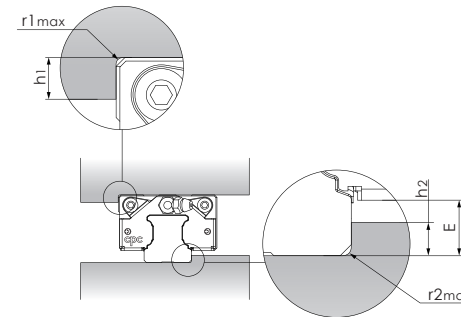

Unit : mm

ARC/HRC/ERC, ARD/HRD/ERD					
Type	r1max	r2max	h1	h2	E
15	0.5	0.5	4.0	2.5	3.3
20	0.5	0.5	5.0	4.0	5.0
25	1.0	1.0	5.0	5.0	6.0
30	1.0	1.0	6.0	5.5	6.6
35	1.0	1.0	6.0	6.5	7.6
45	1.0	1.0	8.0	8.0	9.3
55	1.5	1.5	10.0	10.0	12.0

WRC					
Type	r1max	r2max	h1	h2	E
21/15	0.4	0.4	5.0	2.0	2.7
27/20	0.4	0.4	5.0	3.0	3.5

ARR/HRR/LRR					
Type	r1max	r2max	h1	h2	E
15	0.5	0.5	4	2	2.9
20	0.5	0.5	5	3.4	4.4
25	1	1	5	4	5
35	1	1	8	5	6
45	1	0.5	10	7	8
55	1.5	1.5	10	8	10

Rail Joint

The standard length of our large rails is 4 meters. If longer rails are required, **cpc** can provide a joint rail solution for which the joint number will be marked on the rail.

- As shown in figure A, please follow the joint number to assemble.
- For more than two units in each axis, to avoid accuracy effects from multiple blocks passing through the same connection point, we advise to use the connection points separately as shown on figure B.
- Please use the slide as a connection point to tighten the slide before tightening the torques to fasten the screws from inside to outside.

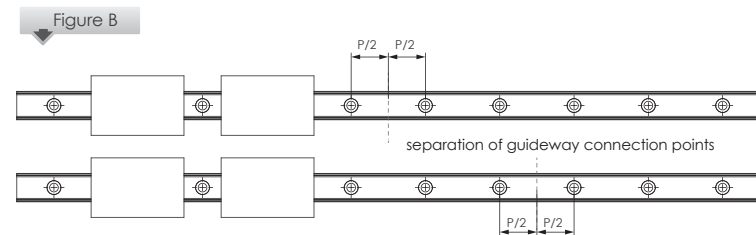

Installation instructions

Installation surface geometry position accuracy

The rough finishing or milling on installation site will impact the working accuracy of linear guide, and reduce the service life of both standard, wide ball type linear guide and roller type linear guide. The accuracy of installation site and linear guides are critical factors to determine the accuracy of work bench. When the error of installation site is larger than the value calculated by following formula, the working resistance and service life will be impacted.

$$e1 \text{ (mm)} = b \text{ (mm)} \cdot f1 \cdot 10^{-4}$$

$$e2 \text{ (mm)} = d \text{ (mm)} \cdot f2 \cdot 10^{-5}$$

$$e3 \text{ (mm)} = f3 \cdot 10^{-3}$$

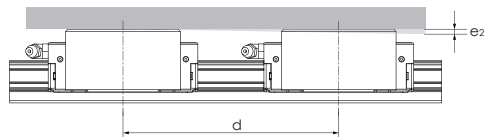
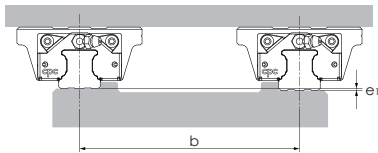

Installation datum plane

Rail: Both edges of rail can be reference edge, it shouldn't be marked separately.

Block: The side steel body of the block with
 1. milled surface
 2. Without groove mark can be the reference side.

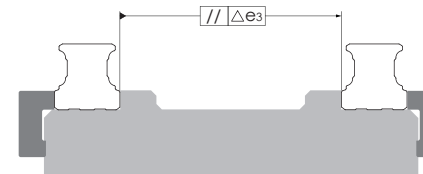

Applicable to 15-55 all models

ARC/HRC/ERC (f1)				
Block length	VC	V0	V1	V2
MS / FS	5.2	3.5	2.2	1.1
MN / FN	4.5	3.1	1.8	0.8
ML / FL	4.2	2.8	1.7	0.7

ARR/HRR/LRR (f1)				
Block length	VC	V0	V1	V2
MN / FN	1.3	1.1	1.0	0.8
ML / FL	1.2	1.1	0.9	0.7
MXL / FXL	1.2	1.0	0.9	0.7

ARC/HRC/ERC (f2)				
Block length	VC	V0	V1	V2
MS / FS	43.1	29.7	18.3	8.9
MN / FN	26.0	17.5	10.5	4.8
ML / FL	18.4	12.3	7.3	3.1

ARR/HRR/LRR (f2)				
Block length	VC	V0	V1	V2
MN / FN	7.1	6.2	5.2	4.3
ML / FL	5.3	4.7	3.9	3.2
MXL / FXL	4.2	3.6	3.0	2.5

ARC (f3)				
Block length	VC	V0	V1	V2
15 MS / FS	20	14	9	5
15 MN / FN	18	13	8	4
15 ML	16	12	7	3
20 MS / FS	25	18	12	6
20 MN / FN	23	16	10	5
20 ML	21	14	9	4
25 MS / FS	31	22	15	8
25 MN / FN	27	20	13	6
30 MS / FS	38	28	18	10
30 MN / FN	33	24	15	8
30 ML	31	22	14	7
35 MN / FN	37	27	17	8
35 ML	35	25	16	8
45 MN	49	35	23	11
45 ML	45	32	21	10
55 MN	65	46	30	15
55 ML	62	44	28	13

HRC / ERC (f3)				
Block length	VC	V0	V1	V2
15 MN / FN / FN-R	18	13	8	4
15 ML / ML-R / FL / FL-R	16	12	7	3
20 MN / FN / FN-R	23	16	10	5
20 ML / ML-R / FL / FL-R	21	14	9	4
25 MS	31	22	15	8
25 MN / FN / FN-R	27	20	13	6
25 ML / ML-R / FL / FL-R	25	18	11	5
30 MN / FN / FN-R	33	24	15	8
30 ML / ML-R / FL / FL-R	31	22	14	7
35 MN / FN / FN-R	37	27	17	8
35 ML / ML-R / FL / FL-R	35	25	16	8
45 MN / FN / FN-R	49	35	23	11
45 ML / ML-R / FL / FL-R	45	32	21	10
55 MN / FN / FN-R	65	46	30	15
55 ML / ML-R / FL	62	44	28	13

ARR/HRR/LRR (f3)			
Block length	V0	V1	V2
15 MN / FN	5	4	2
15 ML / FL	5	3	2
20 MN / FN	7	5	2
20 ML / FL	6	4	2
25 MN / FN	7	5	2
25 ML / FL	7	5	2
25 MXL / FXL	6	5	2
35 MN / FN	9	6	3
35 ML / FL	8	5	2
35 MXL / FXL	8	5	2

ARR/HRR/LRR (f3)			
Block length	V0	V1	V2
45 MN / FN	11	7	4
45 ML / FL	10	7	3
45 MXL / FXL	10	6	3
55 MN / FN	13	9	4
55 ML / FL	12	9	4
55 MXL / FXL	11	8	3

Installation instructions

Rail installation

Diagram	Description	Feature
	<ul style="list-style-type: none"> No Straightening Not allowed 	No precision Low lateral bearing capacity
	<ul style="list-style-type: none"> Straightening by pin Not suggested 	Low precision Low lateral bearing capacity
	<ul style="list-style-type: none"> Straightening based on straight edge, calibrated by meter 	Low to mid precision Low lateral bearing capacity
	<ul style="list-style-type: none"> Place the rail on a supporting edge (Precision vise applied) 	High precision One side with high lateral bearing capacity
	<ul style="list-style-type: none"> With support edge and lateral mounting screw 	Very high precision High lateral bearing capacity on both sides.

Recommended precision measurement method

The working accuracy of linear guide is defined by the parallelism between block and rail (height, side). In practical application the linear accuracy is required, the measuring method is diverse, so we would suggest following measure to acquire the linear accuracy of linear guide.

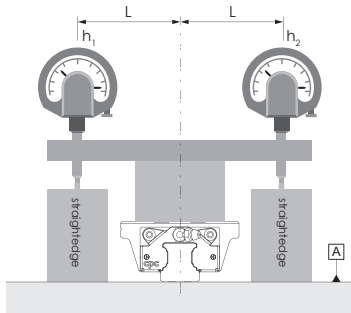

H The horizontal working accuracy $\parallel P \perp$
 base plane flatness $\square A = |h_1 - h_2|_{\text{total length}}$
 (above mentioned method can be used to exclude the skew error of rail on roll direction)

* When the error of flatness of base plane is 0, the value is the linear working accuracy of rail at the certain height
 (Please refer to table of working precision page 31)

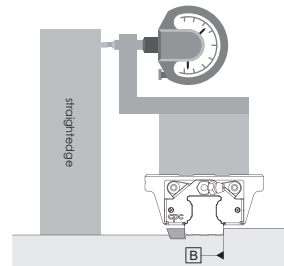

W₂ The horizontal working accuracy $\parallel P \perp$
 the straightness of rail installation $\text{—} B$

*When the error of the straightness of the rail is 0, the value is the horizontal working accuracy on the side.
 (Please refer to table of working precision page 31)

Lubrication

Function

When operating the linear guides under sufficient lubrication, a one-micron layer of the oil film at the contact zone separating the loaded rolling elements and the raceway.

Sufficient lubrication will:

- Reduce the friction
- Minimize wear
- Prevent oxidation
- Dissipate heat and increase operating life.

Lubrication methods and note on lubrication

- The block already contains lubricants that can be directly installed on the machine without additional cleaning.
- If cleaning of the block is required which the oil storage is equipped, please wait until the cleanser and clean naphtha in the oil storage are dry, and then put the block in lubricating oil, so that the oil storage can absorb enough lubricating oil before it will be installed in Machine.
- Before the first start-up, the carriage and the rail must be protected by adding lubricating grease and contact with liquid or solid contaminants must be avoided.
- The cpc block is provided with lubrication holes at the front and rear ends, as well as left and right and on the top. The grease can be injected into the block through the holes. The amount of grease required for a single block is given in the table below.
- The block must run back and forth while lubricating.
- Must consistently provide an oil film on the surface of the rail, which is easily noticeable optically.
- If dry and discolored, relubrication should be carried out immediately, and the relubrication interval should be determined according to the environment and conditions of use.
- The user must inform in advance if it is used in a cleanroom environment or requires acid and alkali resistance.
- If the use of a guide deviates from the horizontal installation, the use of oil lubrication must be carefully checked.
- The re-lubrication interval must be shortened if the travel stroke is < 2 or > 15 times the length of the steel body of the runner block.
- If the stroke is less than two times the steel body of the block, the grease must be injected through the lubrication hole from the left and right of the block and then run on a rail that is at least three times the length of the block to distribute the grease evenly in the block. Repeat this step twice.
- For the central lubrication system, cpc recommends the use of liquid grease NLGI 00 or NLGI 000.

Precautions when lubrication with oil

- If indicate "oil lubrication" on the order, the carriage provided will not be pre-filled with grease.
- If the block already has grease inside and the grease is different from the grease set by the customer or has exceeded the 12-month shelf life, you must clean the block before assembling. Test the lubricants to avoid grease incompatibility. Ensure that the channel is free, and the lubricant can flow to the rolling elements and be lubricated.
- If using the grease nipple combined with the tubing kit or the set screws for the lubricating oil inlet channel, must wrap it with a tapseal to achieve a leakproof effect.

Space for grease in the block inside

Size	ARC/HRC/ERC, ARD/HRD/ERD		
	short (S)	standard (N)	long (L)
15	1.4	2	3.2
20	2.3	4	5.5
25	3.9	7	9.5
30	5.9	10	14
35	-	16	21
45	-	32	40
55	-	53	66.5

Size	WRC	
	standard (N)	
21/15	2.7	
27/20	5.3	

Size	ARR/HRR/LRR		
	standard (N)	long (L)	extra long (XL)
15	3.7	4.5	-
20	6.1	7.2	-
25	9.5	10.8	11.9
30	12.4	13.7	15.1
35	16.2	18.0	21.3
45	22	26.4	30.8
55	31.2	38.5	46.8

Size	ARC/HRC/ERC, ARD/HRD/ERD (ball chain type)		
	short (S)	standard (N)	long (L)
15	1.2	1.5	2.5
20	2.3	3.5	5
25	3.9	7	9
30	5.4	9	12.5
35	-	15	19.5
45	-	30	37
55	-	-	-

Size	WRC (ball chain type)	
	standard (N)	
21/15	2.2	
27/20	4.8	

Size	ARR/HRR/LRR (roller chain type)		
	standard (N)	long (L)	extra long (XL)
15	3.1	3.9	-
20	5.0	6.3	-
25	8.5	9.7	10.8
30	11.2	12.5	13.9
35	14.7	16.5	19.8
45	20.8	24.3	27.7
55	30.6	37.8	46

Technical information

Accuracy

The ARC/HRC/ERC, ARD/HRD/ERD, WRC linear guides provide 5 different grades of precision : N, H, P, SP, and UP, Engineers can choose different grades depending on the machine applications.

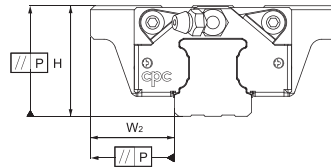

Accuracy

Size	Accuracy grades (μm)		UP	SP	P	H	N
15 ~ 20	Tolerance of dimension height H	H	± 5	± 10	± 15	± 30	± 70
	Variation of height for different runner blocks on the same position of Rail	Δ H	3	5	6	10	20
	Tolerance of dimension width W ₂	W ₂	± 5	± 7	± 10	± 20	± 40
	Variation of width for different runner blocks on the same position of Rail	Δ W ₂	3	5	7	15	30
25 ~ 35	Tolerance of dimension height H	H	± 5	± 10	± 20	± 40	± 80
	Variation of height for different runner blocks on the same position of Rail	Δ H	3	5	7	15	20
	Tolerance of dimension width W ₂	W ₂	± 5	± 7	± 10	± 20	± 40
	Variation of width for different runner blocks on the same position of Rail	Δ W ₂	3	5	7	15	30
45 ~ 55	Tolerance of dimension height H	H	± 5	± 10	± 20	± 40	± 80
	Variation of height for different runner blocks on the same position of Rail	Δ H	3	5	7	15	25
	Tolerance of dimension width W ₂	W ₂	± 5	± 7	± 10	± 20	± 40
	Variation of width for different runner blocks on the same position of Rail	Δ W ₂	3	5	7	15	30

Runner block relative to linear guide, datum plane parallel motion precision

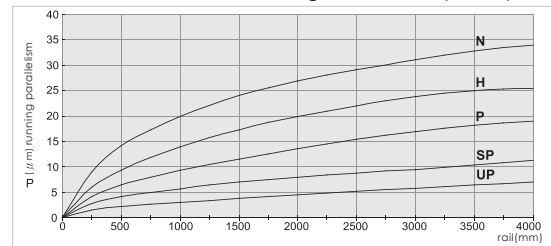

Application

class	Movement, Conveyance	Manufacturing Equipment	High Precision Manufacturing Equipment	Measuring Equipment
N	●	●		
H	●	●	●	
P		●	●	●
SP			●	●
UP				●
Examples	1. Conveyance system 2. Industrial robots 3. Office Machinery	1. Woodworking machine 2. Punching press 3. Injection Molding machine	1. Lathe/milling machine/ grinding machine 2. Electrical discharge machining (EDM) 3. CNC machining center	1. Three dimensional measuring instrument 2. Detection mirror / head shaft 3. X-Y Table

Ordering information

Length of Rail

Butt-jointing is required when lengths exceed Lmax.
(For more detailed information, please contact **cpc** for technical support.)

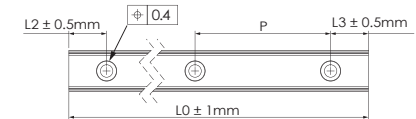

ARC	U	15	M	N	-R	B	2	Z	C	V1	P	-1480L	-20	-20	II	/J	Customization code
																	Number of rails on the same moving axis
																	End hole pitch (mm)*
																	Starting hole pitch (mm)*
																	Rail length (mm)
																	Accuracy grade : UP, SP, P, H, N
																	Preload class : VC, V0, V1, V2
																	C: with ball chain
																	Z: with lubrication storage pad
																	Block quantity
																	Seal type : B: Low friction S: Standard
																	R: six mounting holes Unlabeled: Standards
																	Block length : L: long N: standard S: short
																	Block width : M: standard F: flanged
																	Block type : 15, 20, 25, 30, 35, 45, 55
																	U: rail (tapped from the bottom)
																	Product type : ARC: automation series HRC/ERC: heavy load series

Customization code(The meaning of suffix characters)

J : slide rail connection	R : special process for rail	SG : installation of side grease holes and set screws
G : customer designated lubricant	VD : customized designated preload pressure value	PC : with plastic caps for counter holes on the rail
I : with Inspection report	OA : block install with grease nipple by cpc (Please contact cpc for direction of grease nipple installation)	MPC : with Metal-Plastic Caps for rail mounting holes.
S : special straightness requirements for rail	DE : reference edges of block and rail on opposite sides	TR : bolt-Hole without chamfer
B : special processing for block	HN : external HNBR seal with metal scraper	
BL : with extension and contraction support layer.	BR : black chrome coating treatment on the rail	RR : raydent coating treatment on the rail
SN : external NBR seal with metal scraper	BB : black chrome coating treatment on the block	RB : raydent coating treatment on the block
BR : black chrome coating treatment on the rail	BRB : black chrome coating treatment on the block and rail	RRB : raydent coating treatment on the block and rail
CB : clear chrome coating treatment on the block	SB : with stainless steel ball bearings	NR : nickel coating treatment on the rail
CRB : clear chrome coating treatment on the block and rail	NRB : nickel coating treatment on the block and rail	NB : nickel coating treatment on the block

Note: For special process or customized requirement, please contact **cpc** for more information.

* The end pitch of the rail should not exceed the 1/2 of original pitch, this is to avoid the misfit of the rail to the workbench.

Dimensions Table

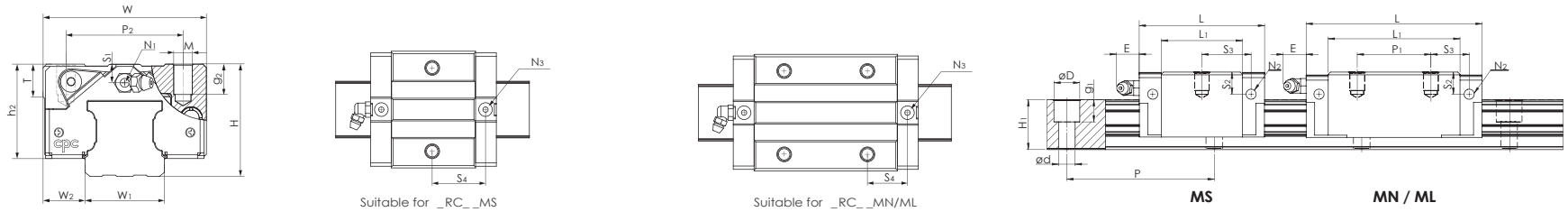

ARC/ERC MS, MN, ML Series

Model Code	Mounting Dimensions		Rail Dimensions(mm)			Block Dimensions(mm)													Block Dimensions(mm)				Load Capacities (kN)				Static Moment (Nm)			Weight		Model Code		
	H	W2	W1 ±0.05	H1	P	Dx dxg1	W	L	L1	h2	P1	P2	P3	MxG2	M1	T	N1	N2	N3	E	S1	S2	S3	S4	C	Co	Mro	Mpo	Myo	Block (g)	Rail (g/m)			
ARC 15 MS	24	9.5	15	15	60	7.5x4.5x5.3	34	41.2	26	20.7	-	26	26	-	M4x7	-	6	M3x6.5	M3x6	P3	5.3	4.5	7.5	15.6	16.7	7.7	12.1	100	50	50	106	1290	ARC 15 MS	
ARC 15 MN								55.5	40.3		26													34	9.8	10.9	9.9	17.5	140	105	105		158	ARC 15 MN
ARC 15 ML								76.2	61		34													16.1	17.2	13.4	26.9	215	235	235	240		ARC 15 ML	
ARC 20 MS	28	11	20	20	60	9.5x6x8.5	42	49.2	32.2	23	-	32	32	-	M5x7	-	8	M3x7.5	M3x5.5	P4	10	4	7.4	19.1	19.8	12.5	19.3	205	100	100	170	2280	ARC 20 MS	
ARC 20 MN								69	52		45													13	13.7	17.1	30.0	325	230	230	266		ARC 20 MN	
ARC 20 ML								87.2	70.2		45													15.6	16.3	20.4	38.5	415	390	390	330		ARC 20 ML	
ARC 25 MS	33	12.5	23	23	60	11x7x9	48	57.4	38.4	27	-	35	35	-	M6x9	-	8	M6x7.5	M3x6.5	P4	12	5	9.3	22.2	23.2	18.2	27.3	350	160	160	300	3020	ARC 25 MS	
ARC 25 MN								81.2	62.2		35													16.6	17.6	24.8	42.5	540	385	385	420		ARC 25 MN	
ERC 25 MS								57.4	38.4		30													22.2	23.2	18.2	27.3	350	160	160	315		ERC 25 MS	
ARC 30 MS	42	16	28	27	80	14x9x12	60	68	44	35.2	-	40	40	-	M8x12	-	12	M6x8.5	M6x5	P5	12	7.5	12	27	26.7	23.3	33.1	520	230	230	560	4380	ARC 30 MS	
ARC 30 MN								95.5	71.5		60													20.8	20.5	32.8	53.7	845	565	565	800		ARC 30 MN	
ARC 30 ML								118	94		60													21.7	21.7	39.6	70.2	1105	950	950	1138		ARC 30 ML	
ARC 35 MN	48	18	34	32	80	14x9x12	70	111.2	86.2	40.4	50	50	-	M8x13	-	14	M6x10	M6x7	P5	12	8	15	23.4	24.1	45.9	82.9	1700	1080	1080	1120	6790	ARC 35 MN		
ARC 35 ML								136.6	111.6		72												25.1	25.8	54.7	106.5	2185	1755	1755	1536		ARC 35 ML		
ARC 45 MN	60	20.5	45	39	105	20x14x17	86	135.5	102.5	50.7	60	60	-	M10x17	-	14	PT1/8x12.5	M6x10.5	P5	14	11.1	18.1	27.3	27.3	71.3	122.1	3200	1910	1910	2120	10530	ARC 45 MN		
ARC 45 ML								171.5	138.5		80												35.3	35.3	89.5	169.1	4430	3460	3460	3160		ARC 45 ML		
ARC 55 MN								168.5	126.5		75												34.8	33.8	108	186	4949	3278	3278	4200		ARC 55 MN		
ARC 55 ML	70	23.5	53	45.7	120	24x16x20	100	202	160	58	75	75	-	M12x20	-	16	M6x10	M6x13	P5	12	13.5	23.5	41.5	40.5	125	226	6472	5284	5284	5083	14000	ARC 55 ML		

- The load capacities is for full-ball type (without ball chain)
- N2 = Injecting holes
- N3 = O-ring size for lubrication from above
- N2, N3 will be sealed before shipment, please open it when first using the product.
- Please refer to the catalog P10 for the size of the screw hole of the reinforcement sheet

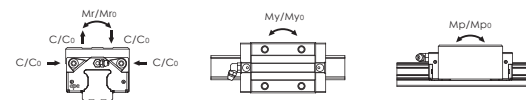

The above rating load capacities and static moments are calculated according to the ISO14728 standard. The rating life for basic dynamic load ratings is defined as the total 100km travel distance for 90% of a group of identical linear guides, under the same conditions and free from any material damage caused by rolling fatigue. If a standard of 50km travel distance is applied to measure the average product lifespan, the above basic dynamic load rating C should be multiplied by 1.26 for an accurate conversion.

Dimensions Table

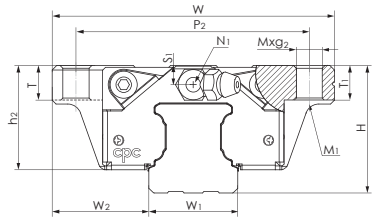

Suitable for ARC 15 FS · FN
ARC 20 FS · FN
ARC 25 FS · FN

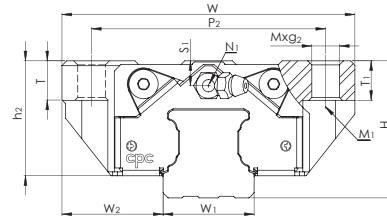

Suitable for ARC 30 FS · FN
ARC 35 FN

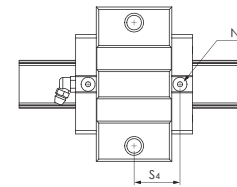

Suitable for ARC __FS

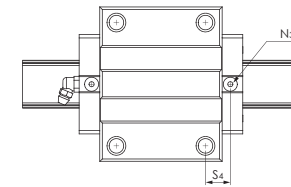

Suitable for ARC __FN

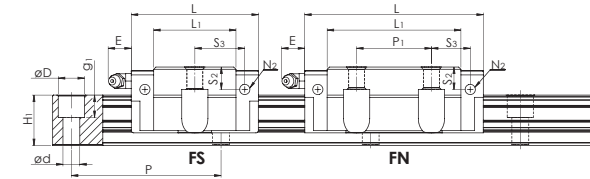

ARC FS, FN Series

Model Code	Mounting Dimensions		Rail Dimensions(mm)			Block Dimensions(mm)											Block Dimensions(mm)				Load Capacities (kN)		Static Moment (Nm)			Weight		Model Code					
	H	W ₂	W ₁ 0.05	H ₁	P	D _x d _x g ₁	W	L	L ₁	h ₂	P ₁	P ₂	P ₃	M _x g ₂	M ₁	T	T ₁	N ₁	N ₂	N ₃	E	S ₁	S ₂	S ₃	S ₄	C	C ₀		M _{r0}	M _{p0}	M _{y0}	Block (g)	Rail (g/m)
ARC 15 FS	24	18.5	15	15	60	7.5x4.5x5.3	52	41.2	26	20.7	-	41	-	M5x7	M4	7	7	M3x6.5	M3x6	P3	5.3	4.5	7.5	15.6	16.7	7.7	12.1	100	50	50	132	1290	ARC 15 FS
ARC 15 FN											26	-	M5x7	M4	7	7	M3x6.5	M3x6	P3	5.3	4.5	7.5	8.9	10.9	9.9	17.5	140	105	105	200	ARC 15 FN		
ARC 20 FS	28	19.5	20	20	60	9.5x6x8.5	59	49.2	32.2	23	-	49	-	M6x10	M5	10	10	M3x7.5	M3x5.5	P4	10	4	7.4	19.1	19.8	12.5	19.3	205	100	100	210	2280	ARC 20 FS
ARC 20 FN											32	-	M6x10	M5	10	10	M3x7.5	M3x5.5	P4	10	4	7.4	13	13.7	17.1	30.0	325	230	230	336	ARC 20 FN		
ARC 25 FS	33	25	23	23	60	11x7x9	73	57.4	38.4	27	-	60	-	M8x10	M6	12	10	M6x7.5	M3x6.5	P4	12	5	9.3	22.2	23.2	18.2	27.3	350	160	160	345	3020	ARC 25 FS
ARC 25 FN											35	-	M8x10	M6	12	10	M6x7.5	M3x6.5	P4	12	5	9.3	16.6	17.6	24.8	42.5	540	385	385	524	ARC 25 FN		
ARC 30 FS	42	31	28	27	80	14x9x12	90	68	44	35.2	-	72	-	M10x12	M8	12	12	M6x8.5	M6x5	P5	12	7.5	12	27	26.8	23.3	33.1	520	230	230	750	4380	ARC 30 FS
ARC 30 FN											40	-	M10x12	M8	12	12	M6x8.5	M6x5	P5	12	7.5	12	20.8	20.5	32.8	53.7	845	565	565	1200	ARC 30 FN		
ARC 35 FN	48	33	34	32	80	14x9x12	100	111.2	86.2	40.4	50	82	-	M10x13	M8	13	13	M6x10	M6x7	P5	12	8	15	23.4	24.1	45.9	82.9	1700	1080	1080	1580	6790	ARC 35 FN

1. The load capacities is for full-ball type (without ball chain)

2. N₂ = Injecting holes

3. N₃ = O-ring size for lubrication from above

4. N₂ N₃ will be sealed before shipment, please open it when first using the product.

5. Please refer to the catalog P10 for the size of the screw hole of the reinforcement sheet

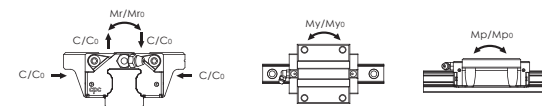

The above rating load capacities and static moments are calculated according to the ISO14728 standard. The rating life for basic dynamic load ratings is defined as the total 100km travel distance for 90% of a group of identical linear guides, under the same conditions and free from any material damage caused by rolling fatigue. If a standard of 50km travel distance is applied to measure the average product lifespan, the above basic dynamic load rating C should be multiplied by 1.26 for an accurate conversion.

Dimensions Table

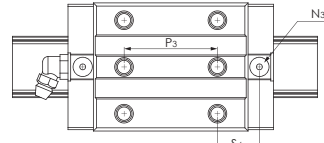
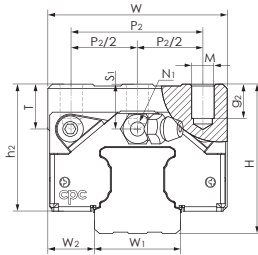

Suitable for _RC_ MN-R/ML-R

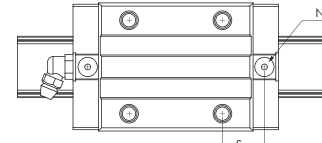

Suitable for _RC_ MN/ML

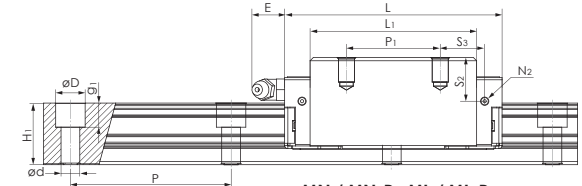

MN / MN-R , ML / ML-R

HRC/ERC MN, ML Series

Model Code	Mounting Dimensions		Rail Dimensions(mm)				Block Dimensions(mm)											Block Dimensions(mm)				Load Capacities (kN)		Static Moment (Nm)			Weight		Model Code				
	H	W ₂	W ₁ ±0.05	H ₁	P	D _x × d _x × g ₁	W	L	L ₁	h ₂	P ₁	P ₂	P ₂ /2	P ₃	M _x × g ₂	M ₁	T	N ₁	N ₂	N ₃	E	S ₁	S ₂	S ₃	S ₄	C	C ₀	M _{r0}		M _{p0}	M _{y0}	Block (g)	Rail (g/m)
HRC 15 MN	28	9.5	15	15	60	7.5x4.5x5.3	34	55.5	40.3	24.7	26	26	-	-	M4x7	-	6	M3x6.5	M3x6	P3	5.3	8.5	11.5	9.8	10.9	9.9	17.5	140	105	105	200	1290	HRC 15 MN
HRC 15 MN-R								13	26				20.1	21.2										13.4	26.9	215	235	235	190	HRC 15 MN-R			
HRC 15 ML								-	-				13	26										280	HRC 15 ML								
HRC 15 ML-R								-	-				13	26										280	HRC 15 ML-R								
HRC 20 MN	30	12	20	20	60	9.5x6x8.5	44	69	52	25	36	32	-	-	M5x8.5	-	8	M3x7.5	M3x5.5	P4	10	6	9.4	11	11.7	17.1	30.0	325	230	230	318	2280	HRC 20 MN
HRC 20 MN-R								16	36				20.1	21.2										13.4	26.9	215	235	235	300	HRC 20 MN-R			
HRC 20 ML								-	-				16	36										280	HRC 20 ML								
HRC 20 ML-R								-	-				16	36										280	HRC 20 ML-R								
ERC 25 MN	36	12.5	23	23	60	11x7x9	48	81.2	62.2	30	35	35	-	-	M6x9	-	8	M6x7.5	M3x6.5	P4	12	8	12.3	16.6	17.6	24.8	42.5	540	385	385	470	3020	ERC 25 MN
ERC 25 MN-R								17.5	35				21	22										30.7	57.7	735	710	710	445	ERC 25 MN-R			
ERC 25 ML								-	-				17.5	35										570	ERC 25 ML								
ERC 25 ML-R								-	-				17.5	35										570	ERC 25 ML-R								
HRC 25 MN	40	12.5	23	23	60	11x7x9	48	81.2	62.2	34	35	35	-	-	M6x9	-	12	M6x7.5	M3x6.5	P4	12	12	16.3	16.6	17.6	24.8	42.5	540	385	385	578	3020	HRC 25 MN
HRC 25 MN-R								17.5	35				21	22										30.7	57.7	735	710	710	560	HRC 25 MN-R			
HRC 25 ML								-	-				17.5	35										685	HRC 25 ML								
HRC 25 ML-R								-	-				17.5	35										645	HRC 25 ML-R								
HRC 30 MN	45	16	28	27	80	14x9x12	60	95.5	71.5	38.2	40	40	-	-	M8x12	-	12	M6x8.5	M6x5	P5	12	10.5	15	20.8	20.5	32.8	53.7	845	565	565	896	4380	HRC 30 MN
HRC 30 MN-R								20	40				21.7	21.8										39.6	70.2	1105	950	950	875	HRC 30 MN-R			
HRC 30 ML								-	-				20	40										1150	HRC 30 ML								
HRC 30 ML-R								-	-				20	40										1100	HRC 30 ML-R								
HRC 35 MN	55	18	34	32	80	14x9x12	70	111.2	86.2	47.4	50	50	-	-	M8x13	-	14	M6x10	M6x7	P5	12	15	22	23.4	24.1	45.9	82.9	1700	1080	1080	1430	6790	HRC 35 MN
HRC 35 MN-R								25	50				25.1	25.8										54.7	106.5	2185	1755	1755	1370	HRC 35 MN-R			
HRC 35 ML								-	-				25	50										1953	HRC 35 ML								
HRC 35 ML-R								-	-				25	50										1800	HRC 35 ML-R								
HRC 45 MN	70	20.5	45	39	105	20x14x17	86	135.5	102.5	60.7	60	60	-	-	M10x20	-	14	PT1/8x12.5	M6x10.5	P5	14	21.1	28.1	27.3	27.3	71.3	122.1	3200	1910	1910	2794	10530	HRC 45 MN
HRC 45 MN-R								30	60				35.3	35.3										89.5	169.1	4430	3460	3460	2650	HRC 45 MN-R			
HRC 45 ML								-	-				30	60										4060	HRC 45 ML								
HRC 45 ML-R								-	-				30	60										3950	HRC 45 ML-R								
HRC 55 MN	80	23.5	53	45.7	120	24x16x20	100	168.5	126.5	68	75	75	-	-	M12x25	-	16	M6x10	M6x13	P5	12	23.5	33.5	34.8	33.8	108	186	4949	3278	3278	5110	14000	HRC 55 MN
HRC 55 MN-R								37.5	75				41.5	40.5										125	226	6472	5284	5284	4900	HRC 55 MN-R			
HRC 55 ML								-	-				37.5	75										6243	HRC 55 ML								
HRC 55 ML-R								-	-				37.5	75										6050	HRC 55 ML-R								

- The load capacities is for full-ball type (without ball chain)
- N₂ = Injecting holes
- N₃ = O-ring size for lubrication from above
- N₂, N₃ will be sealed before shipment, please open it when first using the product.
- Please refer to the catalog P10 for the size of the screw hole of the reinforcement sheet

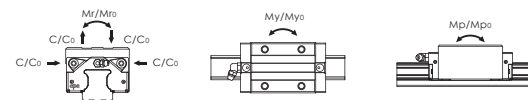

The above rating load capacities and static moments are calculated according to the ISO14728 standard. The rating life for basic dynamic load ratings is defined as the total 100km travel distance for 90% of a group of identical linear guides, under the same conditions and free from any material damage caused by rolling fatigue. If a standard of 50km travel distance is applied to measure the average product lifespan, the above basic dynamic load rating C should be multiplied by 1.26 for an accurate conversion.

Dimensions Table

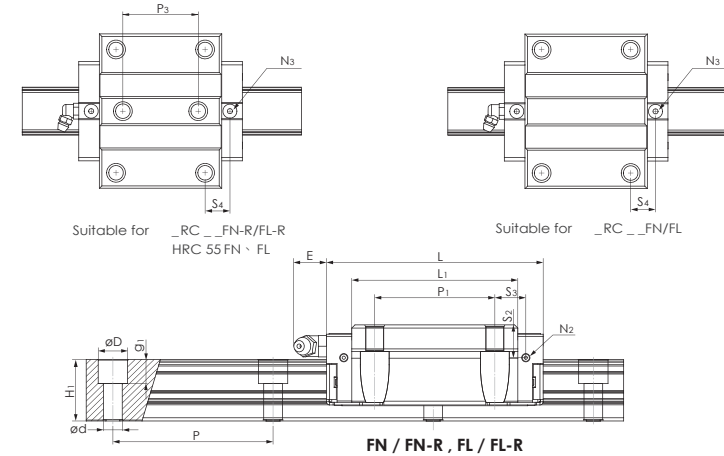
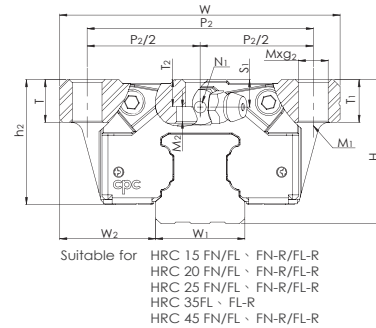
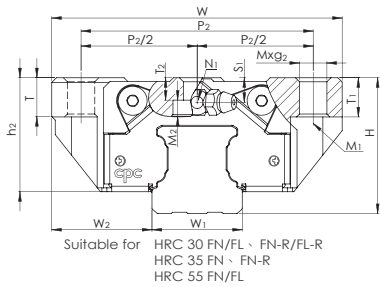

HRC FN, FL Series

Model Code	Mounting Dimensions		Rail Dimensions(mm)				Block Dimensions(mm)											Load Capacities (kN)				Static Moment (Nm)			Weight		Model Code									
	H	W2	W1 0.05	H1	P	Dxdxg1	W	L	L1	h2	P1	P2	P2/2	P3	Mxg2	M1	M2	T	T1	T2	N1	N2	N3	E	S1	S2		S3	S4	C	C0	Mro	Mpo	Myo	Block (g)	Rail (g/m)
HRC 15 FN	24	16	15	15	60	7.5x4.5x5.3	47	55.5	40.3	20.7	30	38	-	-	M5x7	M4	-	7	7	-	M3x6.5	M3x6	P3	5.3	4.5	7.5	7.8	8.9	9.9	17.5	140	105	105	190	1290	HRC 15 FN
HRC 15 FN-R								19	26				2.8	4.4			175			HRC 15 FN-R																
HRC 15 FL								-	-				-	-			290			HRC 15 FL																
HRC 15 FL-R								19	26				2.8	4.4			270			HRC 15 FL-R																
HRC 20 FN	30	21.5	20	20	60	9.5x6x8.5	63	69	52	25	40	53	-	-	M6x10	M5	-	10	10	-	M3x7.5	M3x5.5	P4	10	6	9.4	9	9.7	17.1	30.0	325	230	230	396	2280	HRC 20 FN
HRC 20 FN-R								26.5	35				3.5	4.4			375			HRC 20 FN-R																
HRC 20 FL								-	-				-	-			504			HRC 20 FL																
HRC 20 FL-R								26.5	35				3.5	4.4			475			HRC 20 FL-R																
HRC 25 FN	36	23.5	23	23	60	11x7x9	70	81.2	62.2	30	45	57	-	-	M8x10	M6	-	12	10	-	M6x7.5	M3x6.5	P4	12	8	12.3	11.6	12.6	24.8	42.5	540	385	385	626	3020	HRC 25 FN
HRC 25 FN-R								28.5	40				4	6.3			550			HRC 25 FN-R																
HRC 25 FL								-	-				-	-			870			HRC 25 FL																
HRC 25 FL-R								28.5	40				4	6.3			810			HRC 25 FL-R																
HRC 30 FN	42	31	28	27	80	14x9x12	90	95.5	71.5	35.2	52	72	-	-	M10x12	M8	-	12	12	-	M6x8.5	M6x5	P5	12	7.5	12	14.8	14.5	32.8	53.7	845	565	565	1110	4380	HRC 30 FN
HRC 30 FN-R								36	44				5	6.8			1000			HRC 30 FN-R																
HRC 30 FL								-	-				-	-			1385			HRC 30 FL																
HRC 30 FL-R								36	44				5	6.8			1290			HRC 30 FL-R																
HRC 35 FN	48	33	34	32	80	14x9x12	100	111.2	86.2	40.4	62	82	-	-	M10x13	M8	-	13	13	-	M6x10	M6x7	P5	12	8	15	17.4	18.1	45.9	82.9	1700	1080	1080	1550	6790	HRC 35 FN
HRC 35 FN-R								41	52				5	7.3			1400			HRC 35 FN-R																
HRC 35 FL								-	-				-	-			2000			HRC 35 FL																
HRC 35 FL-R								41	52				5	7.3			1800			HRC 35 FL-R																
HRC 45 FN	60	37.5	45	39	105	20x14x17	120	135.5	102.5	50.7	80	100	-	-	M12x15	M10	-	18	15	-	PT1/8x12.5	M6x10.5	P5	14	11.1	18.1	17.3	17.3	71.3	122.1	3200	1910	1910	2747	10530	HRC 45 FN
HRC 45 FN-R								50	60				6	9.8			2550			HRC 45 FN-R																
HRC 45 FL								-	-				-	-			4280			HRC 45 FL																
HRC 45 FL-R								50	60				6	9.8			4050			HRC 45 FL-R																
HRC 55 FN	70	43.5	53	45.7	120	24x16x20	140	168.5	126.5	58	95	116	58	70	M14x18	M12	13	18	18	9.4	M6x10	M6x13	P5	12	13.5	23.5	24.8	23.8	108	186	4949	3278	3278	5440	14000	HRC 55 FN
HRC 55 FL								202	160				41.5	40.5			125			226							6472	5284	5284	6963	HRC 55 FL					

- The load capacities is for full-ball type (without ball chain)
- N2 = Injecting holes
- N3 = O-ring size for lubrication from above
- N2, N3 will be sealed before shipment, please open it when first using the product.
- Mxg2, M1: Screw size according to ISO 4762-12.9
- M2 countersunk screw size according to DIN 7984-8.8
- Please refer to the catalog P10 for the size of the screw hole of the reinforcement sheet

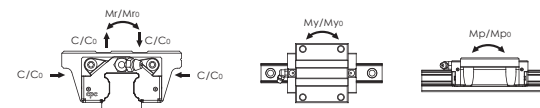

The above rating load capacities and static moments are calculated according to the ISO14728 standard. The rating life for basic dynamic load ratings is defined as the total 100km travel distance for 90% of a group of identical linear guides, under the same conditions and free from any material damage caused by rolling fatigue. If a standard of 50km travel distance is applied to measure the average product lifespan, the above basic dynamic load rating C should be multiplied by 1.26 for an accurate conversion.

Dimensions Table

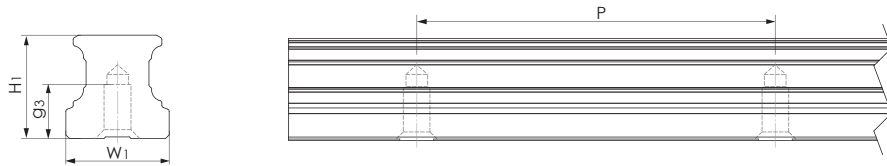

Rail (tapped from the bottom)

Model Code	W ₁	H ₁	P	Mxg ₃	L _{max}	Mass (g/m)
ARU 15	15	15	60	M5x8	4000	1290
ARU 20	20	20	60	M6x10	4000	2280
ARU 25	23	23	60	M6x12	4000	3020
ARU 30	28	27	80	M8x15	4000	4380
ARU 35	34	32	80	M8x15	4000	6790
ARU 45	45	39	105	M12x19	4000	10530
ARU 55	53	45.7	120	M14x24	4000	14060

Nipple Option

	Type			Nipple size		Grease nipple		Optional		
				Section	Side	Standard	Straight adapter	Tube diameter	L-type adapter	Tube diameter
Ball	ARC/ARD15	HRC/HRD15	-	M3	M3	A-M3	OA-M3-D4	-	OB-M3-M6	-
	ARC/ARD20	HRC/HRD20	-	M3	M3	B-M3	OA-M3-D4	-	OB-M3-M6	-
	ARC/ARD25	HRC/HRD25	ERC/ERD25	M6	M3	A/B-M6	OA-M6-M8	Ø4	OB-M6-M8	Ø4
	ARC/ARD30	HRC/HRD30	-	M6	M6	A/B-M6	OA-M6-M8	Ø4	OB-M6-M8	Ø4
							OA-M6-PT1/8	-	-	-
	ARC/ARD35	HRC/HRD35	-	M6	M6	A/B-M6	OA-M6-M8	Ø4	OB-M6-M8	-
							OA-M6-PT1/8	-	-	-
	ARC/ARD45	HRC/HRD45	-	PT1/8	M6	B-PT1/8	OA-M6-G1/8	Ø6	OB-M6-PT1/8	-
							OA-PT1/8-M8	Ø4	OB-PT1/8-M8	Ø4
	ARC/ARD55	HRC/HRD55	-	M6	M6	A/B-M6	OA-PT1/8-PT1/8	-	-	-
OA-M6-M8							Ø4	OB-M6-M8	Ø4	
Roller	ARR15	HRR15	-	M3	M3	A/B-M3	OA-M3-D4	-	OB-M3-M6	-
	ARR20	HRR20	-	M4	M4	A/B-M4	OA-M4-D4	-	OB-M4-M6	-
	ARR25	HRR25	-	M6	M6	A/B-M6	OA-M6-M8	Ø4	OB-M6-M8	Ø4
	ARR35	HRR35	LRR35	M6	M6	A/B-M6-L	OA-M6-M8-L	Ø4	OB-M6-M8-L	Ø4
							OA-M6-PT1/8-L	-	-	-
	ARR45	HRR45	LRR45	M6	M6	A/B-M6-L	OA-M6-G1/8-L	Ø6	OB-M6-PT1/8-L	-
							OA-M6-M8-L	Ø4	OB-M6-M8-L	Ø4
	ARR55	HRR55	LRR55	M6	M6	A/B-M6	OA-M6-PT1/8-L	-	-	-
							OA-M6-G1/8-L	Ø6	OB-M6-PT1/8-L	-
							OA-M6-M8	Ø4	OB-M6-M8	Ø4
						OA-M6-PT1/8	-	-	-	
						OA-M6-G1/8	Ø6	OB-M6-PT1/8	-	

* When external NRB seal is chosen (SN), please use long type grease nipple for ball type product, extra long type grease nipple for roller type product.



WRC series
Wide Rail Ball Type Linear Guide Series

Ordering information

Length of Rail

Butt-jointing is required when lengths exceed L_{max}.
(For more detailed information, please contact **cpc** for technical support.)

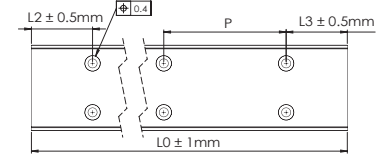

Model code

WRC	U	21/15	M	N	B	2	Z	C	V1	P	-1480L	-20	-20	II	/J
Customization code (Please refer to page 32)															
Number of rails on the same moving axis															
End hole pitch (mm)															
Starting hole pitch (mm)															
Rail length (mm)															
Accuracy grade : UP, SP, P, H, N (Please refer to page 31)															
Preload class : VC, V0, V1, V2 (Please refer to page 25)															
C: with ball chain (Please refer to page 07)															
Z: with lubrication storage pad (available: 21/15)															
Block quantity															
Seal type : B: Low friction S: Standard type S seal (available: 21/15)															
Block length : N: standard															
Block width : M: standard F: flanged															
Block type : 21/15, 27/20															
U: rail (tapped from the bottom)															
Product type : WRC: Wide Rail Ball Type Linear Guide Series															

Dimensions Table WRU Series Rail (tapped from the bottom)

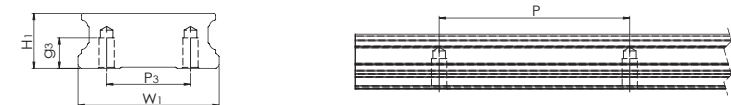

Model Code	W ₁	H ₁	P	P ₃	Mxg ₃	L _{max}	Mass (g/m)
WRU 21/15	37	14.4	50	22	M4x8	4000	3596
WRU 27/20	42	18.5	60	24	M5x7.5	4000	5259

Dimensions Table

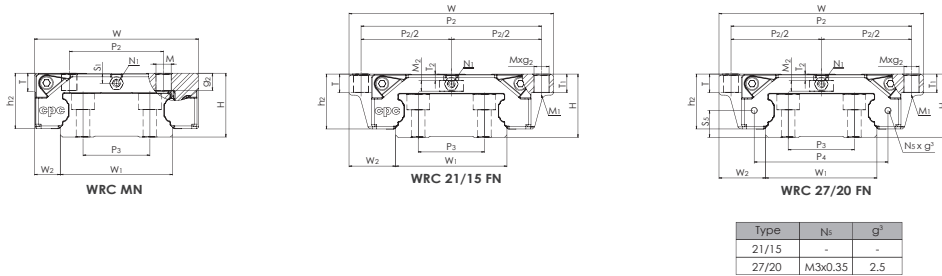

Type	Ni	g²
21/15	-	-
27/20	M3x0.35	2.5

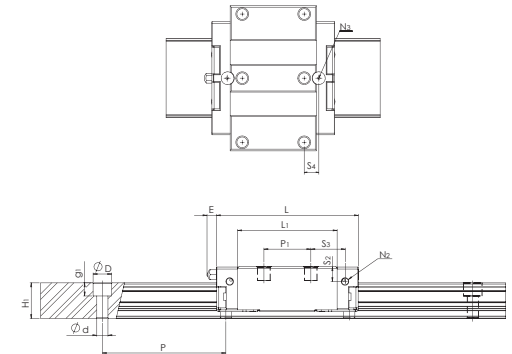
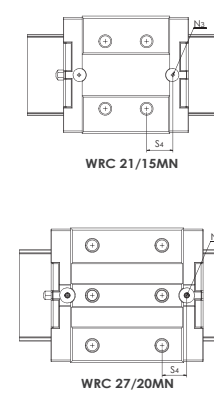

WRC Series

Model Code	Mounting Dimensions			Rail Dimensions(mm)				Block Dimensions(mm)												Block Dimensions(mm)					Load Capacities (kN)			Static Moment (Nm)			Weight		Model Code						
	H	W2	W1 0.05	H1	P	P3	Dx dxg1	W	L	L1	h2	P1	P2	P2/2	P4	Mxg2	M1	M2	T	T1	T2	N1	N2	N3	E	S1	S2	S3	S4	S5	Ciso			C0	Mro	Mpo	Myo	Block(g)	Rail(g/m)
																															100km	50km							
WRC 21/15 MN	21	8.5	37	14.4	50	22	7.5x4.5x5.3	54	57.5	40.3	18.3	19	31	-	-	M5x5	-	-	6	-	-	M3	M3x3	P3	5.3	3.3	6.1	13.9	11.9	-	9.9	12.5	17.5	315	105	105	160	3596	WRC 21/15 MN
WRC 21/15 FN		15.5						68				29	60	30		M5x7	M4	2.1	7	7	3.6																198		WRC 21/15 FN
WRC 27/20 MN	27	10	42	18.5	60	24	7.5x4.5x5.3	62	70	52	23.5	32	46	23		M6x6	-	-	10	-	-	M3	M3x4	P4	5.3	4.5	8	13.2	11.5		17.1	21.5	30	634	230	230	320	5259	WRC 27/20 MN
WRC 27/20 FN		19						80				40	70	35	50	M6x9	M5	4.6	9	9	3															553		WRC 27/20 FN	

The above rating load capacities and static moments are calculated according to the ISO14728 standard. The rating life for basic dynamic load ratings is defined as the total 100km travel distance for 90% of a group of identical linear guides under the same conditions and free from any material damage caused by rolling fatigue. If a standard of 50km travel distance is applied to measure the average product lifespan, the above basic dynamic load rating C should be multiplied by 1.26 for an accurate conversion.

WRC...C Series Ball chain type

Model Code	Mounting Dimensions			Rail Dimensions(mm)				Block Dimensions(mm)												Block Dimensions(mm)					Load Capacities (kN)			Static Moment (Nm)			Weight		Model Code						
	H	W2	W1 0.05	H1	P	P3	Dx dxg1	W	L	L1	h2	P1	P2	P2/2	P4	Mxg2	M1	M2	T	T1	T2	N1	N2	N3	E	S1	S2	S3	S4	S5	Cccage			C0	Mro	Mpo	Myo	Block(g)	Rail(g/m)
																															100km	50km							
WRC 21/15 MN...C	21	8.5	37	14.4	50	22	7.5x4.5x5.3	54	57.5	40.3	18.3	19	31	-	-	M5x5	-	-	6	-	-	M3	M3x3	P3	5.3	3.3	6.1	13.9	11.9	-	11.8	14.9	16.2	295	95	95	160	3596	WRC 21/15 MN...C
WRC 21/15 FN...C		15.5						68																				29	60								30		M5x7
WRC 27/20 MN...C	27	10	42	18.5	60	24	7.5x4.5x5.3	62	70	52	23.5	32	46	23	50	M6x6	-	-	10	-	-	M3	M3x4	P4	5.3	4.5	8	13.2	11.5	11	22.3	28.1	25.7	535	200	200	320	5259	WRC 27/20 MN...C
WRC 27/20 FN...C		19						80																				40	70								35		M6x9

The dynamic load rating value with ball chain Ccage is the measured value (please refer to page 08). The above static load rating and the static moment are calculated according to the ISO 14728 standard.

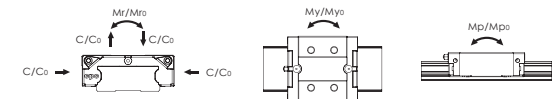

ARD/HRD/ERD series

Standard 4-Row Ball Bearing Linear Guide Equipped with Cover Strip

Product features

- Equipped with cover strip
- High dustproof effectiveness
- Easy installation
- Available in all sizes: 15-55
- Length of the cover strip will be the same as the guide rail
- Fixed device provided on both ends
- Under normal use, the metal cover can be installed and removed repeatedly

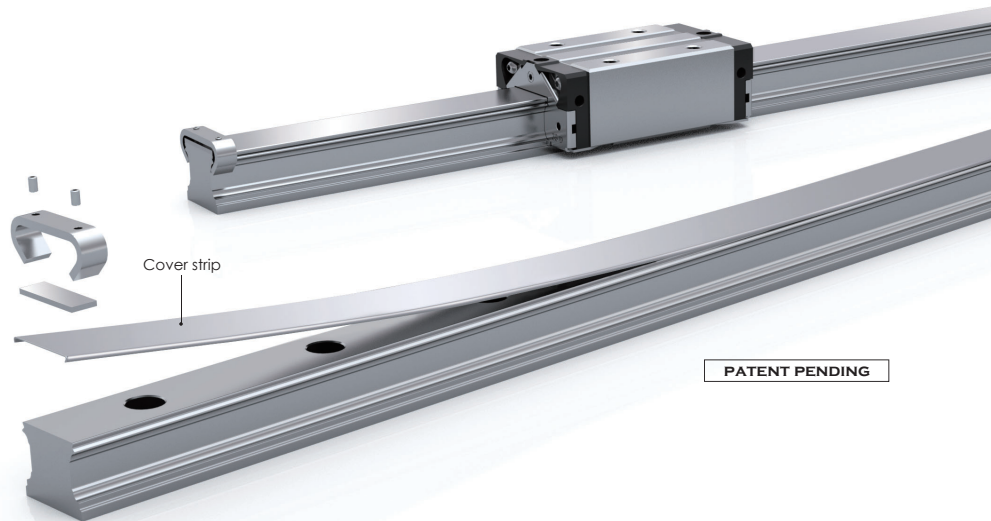

Installation

STEP 1.

Mounting the rail against the reference edge and tighten the screws; measuring the accuracy within the tolerance to ensure a correct mounting process.

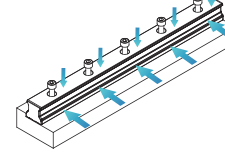

STEP 2.

1. Put the cover strip on one side of the rail.
2. Press down the cover strip on the other side to make it fit the rail.

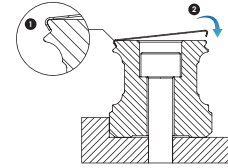

STEP 3.

The gap at both ends better to be the same.

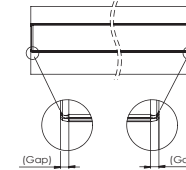

STEP 4.

1. Place the press plate on the cover strip.
2. Slide the metal stopper over the plate.
3. Tighten the screws slightly; the press plate is attached to the cover strip, the rounded surface is attached to the cover strip. Add some lubricating oil. Moving the stopper set forward to the other end by pushing the rigid block, thereafter fix on the rail top surface tightly.
4. Tighten the screws to fix the stopper on one end of the cover strip.

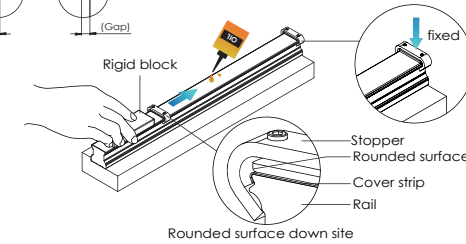

STEP 5.

Mounting the block onto the rail. "Attention the reference side on the right side."

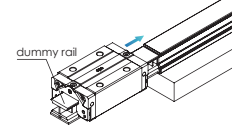

STEP 6.

After the block and the rail are assembled, fix the other stopper on the other end of the cover strip.

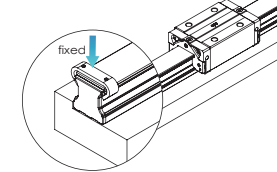

The installation is complete.

Ordering information

Model code

ARD	15	M	N	-R	S	2	Z	C	V1	P	-1480L	-20	-20	II	/J	
Customization code																
Number of rails on the same moving axis																
End hole pitch (mm)																
Starting hole pitch (mm)																
Rail length (mm)																
Accuracy grade : UP, SP, P, H, N																
Preload class : VC, V0, V1, V2																
C: with ball chain (Available for size 15,20,25,30,35 and 45)																
Z: with lubrication storage pad (Available for size 15,20,25,30,35 and 45)																
Block quantity																
Seal type : S: Standard																
R: six mounting holes Unlabeled: Standards																
Block length : L: long N: standard S: short																
Block width : M: standard F: flanged																
Block type : 15, 20, 25, 30, 35, 45, 55																
Product type : ARC/ARD: automation series HRC/ERC/HRD/ERD: heavy load series																

Dimensions Table

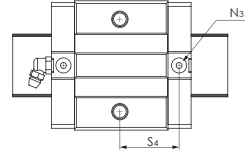
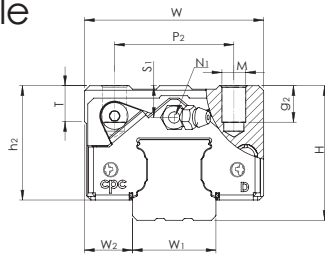

Suitable for _RD_ _MS

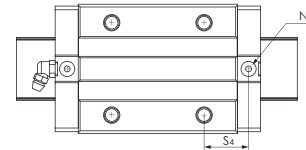

Suitable for _RD_ _MN/ML

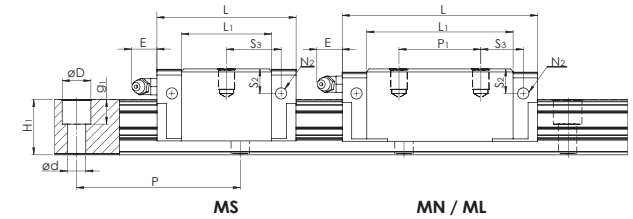

MS

MN / ML

ARD/ERD MS, MN, ML Series

Model Code	Mounting Dimensions		Rail Dimensions(mm)			Block Dimensions(mm)											Block Dimensions(mm)				Load Capacities (kN)				Static Moment (Nm)			Weight		Model Code				
	H	W2	W1 0-0.05	H1	P	Dxdxg1	W	L	L1	h2	P1	P2	P3	MxG2	M1	T	N1	N2	N3	E	S1	S2	S3	S4	C	Co	Mr0	Mp0	My0		Block (g)	Rail (g/m)		
ARD 15 MS	24	9.5	15	15.15	60	7.5x4.5x5.3	34	41.2	26	20.7	-	26	26	-	M4x7	-	6	M3x6.5	M3x6	P3	5.3	4.5	7.5	15.6	16.7	7.7	12.1	100	50	50	106	1290	ARD 15 MS	
ARD 15 MN								55.5	40.3		26													34	9.8	10.9	9.9	17.5	140	105	105		158	ARD 15 MN
ARD 15 ML								76.2	61		34													16.1	17.2	13.4	26.9	215	235	235	240		ARD 15 ML	
ARD 20 MS	28	11	20	20.2	60	9.5x6x8.5	42	49.2	32.2	23	-	32	32	-	M5x7	-	8	M3x7.5	M3x5.5	P4	10	4	7.4	19.1	19.8	12.5	19.3	205	100	100	170	2280	ARD 20 MS	
ARD 20 MN								69	52		32													45	13	13.7	17.1	30.0	325	230	230		266	ARD 20 MN
ARD 20 ML								87.2	70.2		45													15.6	16.3	20.4	38.5	415	390	390	330		ARD 20 ML	
ARD 25 MS	33	12.5	23	23.2	60	11x7x9	48	57.4	38.4	27	-	35	35	-	M6x9	-	8	M6x7.5	M3x6.5	P4	12	5	9.3	22.2	23.2	18.2	27.3	350	160	160	300	3020	ARD 25 MS	
ARD 25 MN								81.2	62.2		35													45	16.6	17.6	24.8	42.5	540	385	385		420	ARD 25 MN
ERD 25 MS								57.4	38.4		30													22.2	23.2	18.2	27.3	350	160	160	315		ARD 25 MS	
ARD 30 MS	42	16	28	27.2	80	14x9x12	60	68	44	35.2	-	40	40	-	M8x12	-	12	M6x8.5	M6x5	P5	12	7.5	12	27	26.7	23.3	33.1	520	230	230	560	4380	ARD 30 MS	
ARD 30 MN								95.5	71.5		40													60	20.8	20.5	32.8	53.7	845	565	565		800	ARD 30 MN
ARD 30 ML								118	94		60													21.7	21.7	39.6	70.2	1105	950	950	1138		ARD 30 ML	
ARD 35 MN	48	18	34	32.3	80	14x9x12	70	111.2	86.2	40.4	50	50	-	M8x13	-	14	M6x10	M6x7	P5	12	8	15	23.4	24.1	45.9	82.9	1700	1080	1080	1120	6790	ARD 35 MN		
ARD 35 ML								136.6	111.6		72												25.1	25.8	54.7	106.5	2185	1755	1755	1536		ARD 35 ML		
ARD 45 MN								135.5	102.5		60												27.3	27.3	71.3	122.1	3200	1910	1910	2120		ARD 45 MN		
ARD 45 ML	60	20.5	45	39.3	105	20x14x17	86	171.5	138.5	50.7	60	60	-	M10x17	-	14	PT1/8x12.5	M6x10.5	P5	14	11.1	18.1	35.3	35.3	89.5	169.1	4430	3460	3460	3160	10530	ARD 45 ML		
ARD 55 MN								168.5	126.5		75												34.8	33.8	108	186	4949	3278	3278	4200		ARD 55 MN		
ARD 55 ML								202	160		95												41.5	40.5	125	226	6472	5284	5284	5083		ARD 55 ML		

1. The load capacities is for full-ball type (without ball chain)
2. N2 = Injecting holes
3. N3 = O-ring size for lubrication from above
4. N2, N3 will be sealed before shipment, please open it when first using the product.
5. Please refer to the catalog P10 for the size of the screw hole of the reinforcement sheet
6. ARD series rail height including cover strip (H1)

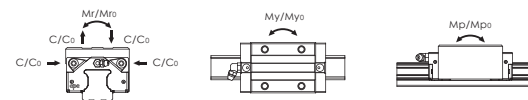

The above rating load capacities and static moments are calculated according to the ISO14728 standard. The rating life for basic dynamic load ratings is defined as the total 100km travel distance for 90% of a group of identical linear guides, under the same conditions and free from any material damage caused by rolling fatigue. If a standard of 50km travel distance is applied to measure the average product lifespan, the above basic dynamic load rating C should be multiplied by 1.26 for an accurate conversion.

Dimensions Table

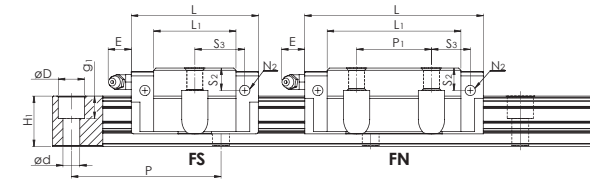
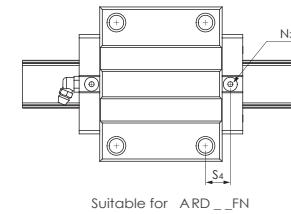
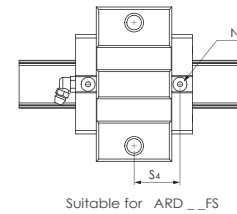
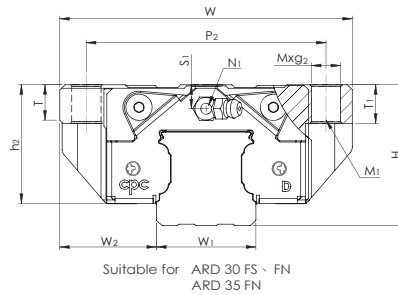
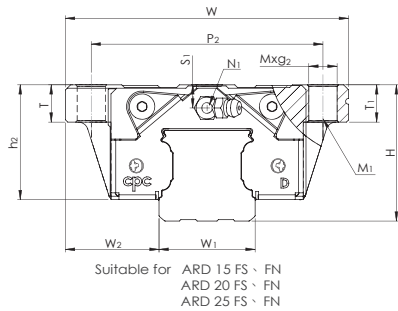

ARD FS, FN Series

Model Code	Mounting Dimensions		Rail Dimensions(mm)			Block Dimensions(mm)													Load Capacities (kN)				Static Moment (Nm)			Weight		Model Code					
	H	W2	W1 0.05	H1	P	Dx dxg1	W	L	L1	h2	P1	P2	P3	MxG2	M1	T	T1	N1	N2	N3	E	S1	S2	S3	S4	C	Co		Mro	Mpo	Myo	Block (g)	Rail (g/m)
ARD 15 FS	24	18.5	15	15.15	60	7.5x4.5x5.3	52	41.2	26	20.7	-	41	-	M5x7	M4	7	7	M3x6.5	M3x6	P3	5.3	4.5	7.5	15.6	16.7	7.7	12.1	100	50	50	132	1290	ARD 15 FS
ARD 15 FN											26	-	M5x7	M4	7	7	M3x6.5	M3x6	P3	5.3	4.5	7.5	8.9	10.9	9.9	17.5	140	105	105	200	ARD 15 FN		
ARD 20 FS	28	19.5	20	20.2	60	9.5x6x8.5	59	49.2	32.2	23	-	49	-	M6x10	M5	10	10	M3x7.5	M3x5.5	P4	10	4	7.4	19.1	19.8	12.5	19.3	205	100	100	210	2280	ARD 20 FS
ARD 20 FN											32	-	M6x10	M5	10	10	M3x7.5	M3x5.5	P4	10	4	7.4	13	13.7	17.1	30.0	325	230	230	336	ARD 20 FN		
ARD 25 FS	33	25	23	23.2	60	11x7x9	73	57.4	38.4	27	-	60	-	M8x10	M6	12	10	M6x7.5	M3x6.5	P4	12	5	9.3	22.2	23.2	18.2	27.3	350	160	160	345	3020	ARD 25 FS
ARD 25 FN											35	-	M8x10	M6	12	10	M6x7.5	M3x6.5	P4	12	5	9.3	16.6	17.6	24.8	42.5	540	385	385	524	ARD 25 FN		
ARD 30 FS	42	31	28	27.2	80	14x9x12	90	68	44	35.2	-	72	-	M10x12	M8	12	12	M6x8.5	M6x5	P5	12	7.5	12	27	26.8	23.3	33.1	520	230	230	750	4380	ARD 30 FS
ARD 30 FN											40	-	M10x12	M8	12	12	M6x8.5	M6x5	P5	12	7.5	12	20.8	20.5	32.8	53.7	845	565	565	1200	ARD 30 FN		
ARD 35 FN	48	33	34	32.3	80	14x9x12	100	111.2	86.2	40.4	50	82	-	M10x13	M8	13	13	M6x10	M6x7	P5	12	8	15	23.4	24.1	45.9	82.9	1700	1080	1080	1580	6790	ARD 35 FN

- The load capacities is for full-ball type (without ball chain)
- N2 = Injecting holes
- N3 = O-ring size for lubrication from above
- N2, N3 will be sealed before shipment, please open it when first using the product.
- Please refer to the catalog P10 for the size of the screw hole of the reinforcement sheet
- ARD series rail height including cover strip (H1)

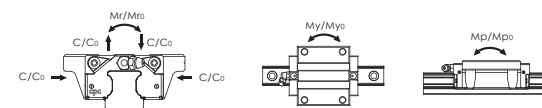

The above rating load capacities and static moments are calculated according to the ISO14728 standard. The rating life for basic dynamic load ratings is defined as the total 100km travel distance for 90% of a group of identical linear guides, under the same conditions and free from any material damage caused by rolling fatigue. If a standard of 50km travel distance is applied to measure the average product lifespan, the above basic dynamic load rating C should be multiplied by 1.26 for an accurate conversion.

Dimensions Table

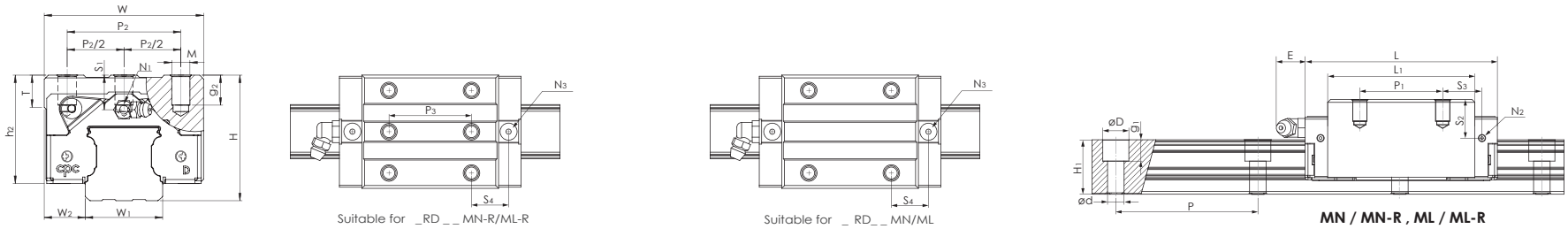

HRD/ERD MN, ML Series

Model Code	Mounting Dimensions		Rail Dimensions(mm)			Block Dimensions(mm)											Load Capacities (kN)				Static Moment (Nm)			Weight		Model Code							
	H	W ₂	W ₁ g _{0.05}	H ₁	P	D _x d _x g ₁	W	L	L ₁	h ₂	P ₁	P ₂	P ₂ /2	P ₃	M _x g ₂	M ₁	T	N ₁	N ₂	N ₃	E	S ₁	S ₂	S ₃	S ₄		C	C ₀	M _{r0}	M _{p0}	M _{y0}	Block (g)	Rail (g/m)
HRD 15 MN	28	9.5	15	15.15	60	7.5x4.5x5.3	34	55.5	40.3	24.7	26	26	-	-	M4x7	-	6	M3x6.5	M3x6	P3	5.3	8.5	11.5	9.8	10.9	9.9	17.5	140	105	105	200	1290	HRD 15 MN
HRD 15 MN-R													13	26										190	HRD 15 MN-R								
HRD 15 ML													-	-										300	HRD 15 ML								
HRD 15 ML-R													13	26										280	HRD 15 ML-R								
HRD 20 MN	30	12	20	20.2	60	9.5x6x8.5	44	69	52	25	36	32	-	-	M5x8.5	-	8	M3x7.5	M3x5.5	P4	10	6	9.4	11	11.7	17.1	30.0	325	230	230	318	2280	HRD 20 MN
HRD 20 MN-R													16	36										300	HRD 20 MN-R								
HRD 20 ML													-	-										400	HRD 20 ML								
HRD 20 ML-R													16	50										370	HRD 20 ML-R								
ERD 25 MN	36	12.5	23	23.2	60	11x7x9	48	81.2	62.2	30	35	35	-	-	M6x9	-	8	M6x7.5	M3x6.5	P4	12	8	12.3	16.6	17.6	24.8	42.5	540	385	385	470	3020	ERD 25 MN
ERD 25 MN-R													17.5	35										445	ERD 25 MN-R								
ERD 25 ML													-	-										610	ERD 25 ML								
ERD 25 ML-R													17.5	50										570	ERD 25 ML-R								
HRD 25 MN	40	12.5	23	23.2	60	11x7x9	48	81.2	62.2	34	35	35	-	-	M6x9	-	12	M6x7.5	M3x6.5	P4	12	12	16.3	16.6	17.6	24.8	42.5	540	385	385	560	3020	HRD 25 MN
HRD 25 MN-R													17.5	35										685	HRD 25 MN-R								
HRD 25 ML													-	-										710	HRD 25 ML								
HRD 25 ML-R													17.5	50										710	HRD 25 ML-R								
HRD 30 MN	45	16	28	27.2	80	14x9x12	60	95.5	71.5	38.2	40	40	-	-	M8x12	-	12	M6x8.5	M6x5	P5	12	10.5	15	20.8	20.5	32.8	53.7	845	565	565	896	4380	HRD 30 MN
HRD 30 MN-R													20	40										875	HRD 30 MN-R								
HRD 30 ML													-	-										1150	HRD 30 ML								
HRD 30 ML-R													20	60										1100	HRD 30 ML-R								
HRD 35 MN	55	18	34	32.3	80	14x9x12	70	111.2	86.2	47.4	50	50	-	-	M8x13	-	14	M6x10	M6x7	P5	12	15	22	23.4	24.1	45.9	82.9	1700	1080	1080	1430	6790	HRD 35 MN
HRD 35 MN-R													25	50										1370	HRD 35 MN-R								
HRD 35 ML													-	-										1953	HRD 35 ML								
HRD 35 ML-R													25	72										1800	HRD 35 ML-R								
HRD 45 MN	70	20.5	45	39.3	105	20x14x17	86	135.5	102.5	60.7	60	60	-	-	M10x20	-	14	PT1/8x12.5	M6x10.5	P5	14	21.1	28.1	27.3	27.3	71.3	122.1	3200	1910	1910	2794	10530	HRD 45 MN
HRD 45 MN-R													30	60										2650	HRD 45 MN-R								
HRD 45 ML													-	-										4060	HRD 45 ML								
HRD 45 ML-R													30	80										3950	HRD 45 ML-R								
HRD 55 MN	80	23.5	53	46	120	24x16x20	100	168.5	126.5	68	75	75	-	-	M12x25	-	16	M6x10	M6x13	P5	12	23.5	33.5	34.8	33.8	108	186	4949	3278	3278	5110	14000	HRD 55 MN
HRD 55 MN-R													37.5	75										4900	HRD 55 MN-R								
HRD 55 ML													-	-										6243	HRD 55 ML								
HRD 55 ML-R													37.5	95										6050	HRD 55 ML-R								

- The load capacities is for full-ball type (without ball chain)
- N₂ = Injecting holes
- N₃ = O-ring size for lubrication from above
- N₂, N₃ will be sealed before shipment, please open it when first using the product.
- Please refer to the catalog P10 for the size of the screw hole of the reinforcement sheet
- ARD series rail height including cover strip (H₁)

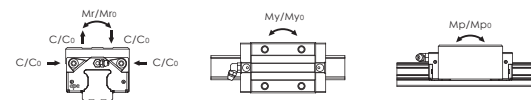

The above rating load capacities and static moments are calculated according to the ISO14728 standard. The rating life for basic dynamic load ratings is defined as the total 100km travel distance for 90% of a group of identical linear guides, under the same conditions and free from any material damage caused by rolling fatigue. If a standard of 50km travel distance is applied to measure the average product lifespan, the above basic dynamic load rating C should be multiplied by 1.26 for an accurate conversion.

Dimensions Table

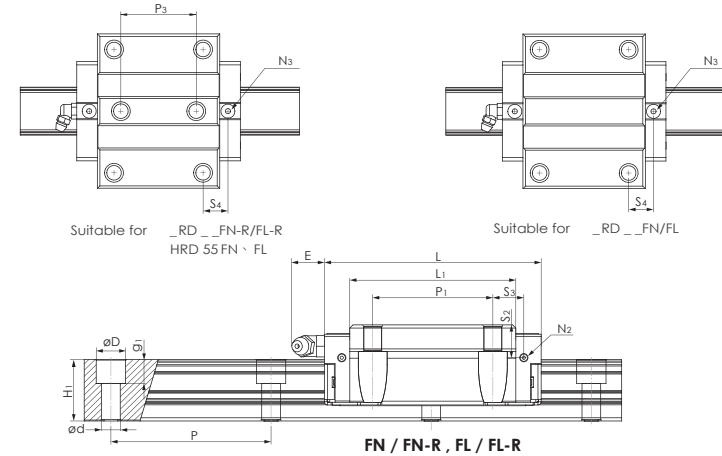
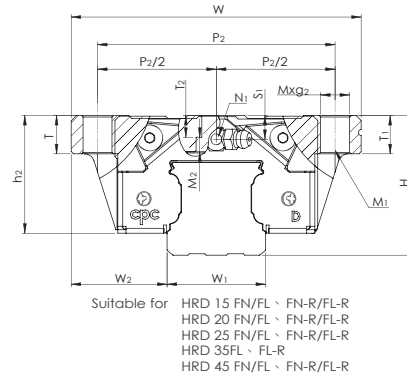
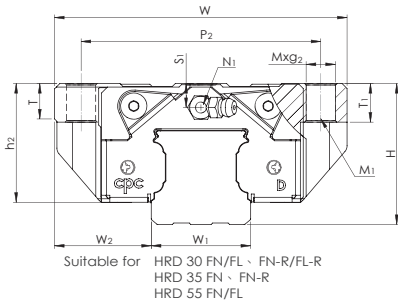

HRD FN, ML Series

Model Code	Mounting Dimensions			Rail Dimensions(mm)			Block Dimensions(mm)														Load Capacities (kN)				Static Moment (Nm)			Weight		Model Code							
	H	W ₂	W ₁ _{0.05}	H ₁	P	Dxdxg ₁	W	L	L ₁	h ₂	P ₁	P ₂	P ₂ /2	P ₃	Mxg ₂	M ₁	M ₂	T	T ₁	T ₂	N ₁	N ₂	N ₃	E	S ₁	S ₂	S ₃	S ₄	C		C ₀	M _{r0}	M _{p0}	M _{y0}	Block (g)	Rail (g/m)	
HRD 15 FN	24	16	15	15.15	60	7.5x4.5x5.3	47	55.5	40.3	20.7	30	38	-	-	M5x7	M4	-	2.8	7	7	-	M3x6.5	M3x6	P3	5.3	4.5	7.5	7.8	8.9	9.9	17.5	140	105	105	190	1290	HRD 15 FN
HRD 15 FN-R													19	26							4.4							175	HRD 15 FN-R								
HRD 15 FL													-	-							-							290	HRD 15 FL								
HRD 15 FL-R													19	26							4.4							270	HRD 15 FL-R								
HRD 20 FN	30	21.5	20	20.2	60	9.5x6x8.5	63	69	52	25	40	53	-	-	M6x10	M5	-	3.5	10	10	-	M3x7.5	M3x5.5	P4	10	6	9.4	9	9.7	17.1	30.0	325	230	230	396	2280	HRD 20 FN
HRD 20 FN-R													26.5	35							4.4							375	HRD 20 FN-R								
HRD 20 FL													-	-							-							504	HRD 20 FL								
HRD 20 FL-R													26.5	35							4.4							475	HRD 20 FL-R								
HRD 25 FN	36	23.5	23	23.2	60	11x7x9	70	81.2	62.2	30	45	57	-	-	M8x10	M6	-	4	12	10	-	M6x7.5	M3x6.5	P4	12	8	12.3	11.6	12.6	24.8	42.5	540	385	385	626	3020	HRD 25 FN
HRD 25 FN-R													28.5	40							6.3							550	HRD 25 FN-R								
HRD 25 FL													-	-							-							870	HRD 25 FL								
HRD 25 FL-R													28.5	40							6.3							810	HRD 25 FL-R								
HRD 30 FN	42	31	28	27.2	80	14x9x12	90	95.5	71.5	35.2	52	72	-	-	M10x12	M8	-	5	12	12	-	M6x8.5	M6x5	P5	12	7.5	12	14.8	14.5	32.8	53.7	845	565	565	1110	4380	HRD 30 FN
HRD 30 FN-R													36	44							6.8							1000	HRD 30 FN-R								
HRD 30 FL													-	-							-							1385	HRD 30 FL								
HRD 30 FL-R													36	44							6.8							1290	HRD 30 FL-R								
HRD 35 FN	48	33	34	32.3	80	14x9x12	100	111.2	86.2	40.4	62	82	-	-	M10x13	M8	-	5	13	13	-	M6x10	M6x7	P5	12	8	15	17.4	18.1	45.9	82.9	1700	1080	1080	1550	6790	HRD 35 FN
HRD 35 FN-R													41	52							7.3							1400	HRD 35 FN-R								
HRD 35 FL													-	-							-							2000	HRD 35 FL								
HRD 35 FL-R													41	52							7.3							1800	HRD 35 FL-R								
HRD 45 FN	60	37.5	45	39.3	105	20x14x17	120	135.5	102.5	50.7	80	100	-	-	M12x15	M10	-	6	18	15	-	PT1/8x12.5	M6x10.5	P5	14	11.1	18.1	17.3	17.3	71.3	122.1	3200	1910	1910	2747	10530	HRD 45 FN
HRD 45 FN-R													50	60							9.8							2550	HRD 45 FN-R								
HRD 45 FL													-	-							-							4280	HRD 45 FL								
HRD 45 FL-R													50	60							9.8							4050	HRD 45 FL-R								
HRD 55 FN	70	43.5	53	46	120	24x16x20	140	168.5	126.5	58	95	116	58	70	M14x18	M12	-	13	18	18	9.4	M6x10	M6x13	P5	12	13.5	23.5	24.8	23.8	108	186	4949	3278	3278	5440	14000	HRD 55 FN
HRD 55 FL								202	160																			41.5	40.5	125	226	6472	5284	5284	6963		HRD 55 FL

- The load capacities is for full-ball type (without ball chain)
- N₂ = Injecting holes
- N₃ = O-ring size for lubrication from above
- N₂, N₃ will be sealed before shipment, please open it when first using the product.
- Mxg₂, M₁: Screw size according to ISO 4762-12.9
- M₂ countersunk screw size according to DIN 7984-8.8
- Please refer to the catalog P10 for the size of the screw hole of the reinforcement sheet
- ARD series rail height including cover strip (H)

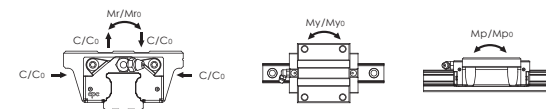

The above rating load capacities and static moments are calculated according to the ISO14728 standard. The rating life for basic dynamic load ratings is defined as the total 100km travel distance for 90% of a group of identical linear guides, under the same conditions and free from any material damage caused by rolling fatigue. If a standard of 50km travel distance is applied to measure the average product lifespan, the above basic dynamic load rating C should be multiplied by 1.26 for an accurate conversion.

ARR/HRR/LRR Roller Guides Series

Product features

- ARR low profile model and HRR standard profile model (Block types: MN/ML/FN/FL) are exactly the same installation dimensions as the other brands.
- The optimized design of the contact surface between the roller and the raceway of the rail has Free-Edge Effect, which greatly improves the load capacity of the roller guide.
- The LRR model with a lower system height
The LRR series with a lower system height, which allows a low center of gravity, offers a more compact height space with the same rated load and rated life.
- High load MXL super long Block model
Compared with the ML model with a long block, MXL model presents a larger rated load and rigidity, and has better vibration absorption capacity.
- Patented silent roller chain (patented design)
Effectively reduce the noise and bumps when the block moves, improve the running smoothness and increase the rated load capacity.
- Built-in oil storage design (patent design)
The built-in oil storage ensures long-term lubrication, which is environmentally friendly and reduces maintenance costs.
- High-rigidity stainless steel reinforcement plate (patent design)
It has a scraping function to maintain a small gap with the rail section to prevent metal chips from intruding. The L-shaped design. The bottom of the steel body is equipped with an integrated milling tenon, which is mutually embedded and powerfully covers the end cover to increase the running speed and acceleration.
- Fully covered sealing design
The blocks of all models are equipped with covered seals, which can effectively prevent foreign matter and dust from invading the blocks and reduce the overflow of lubricating oil in the blocks.
- High precision
The appropriate accuracy level can be selected according to different applications
- Metal cover strip (patent design)
All types of slides are available for selection, and can prevent foreign matter from intruding in harsh environments and have a high dust-proof effect.
- Metal plastic cap (patent design)
Patented design, easy installation, stainless steel upper cover can show excellent wear resistance and dust resistance in harsh environments.

Roller Guide Structure

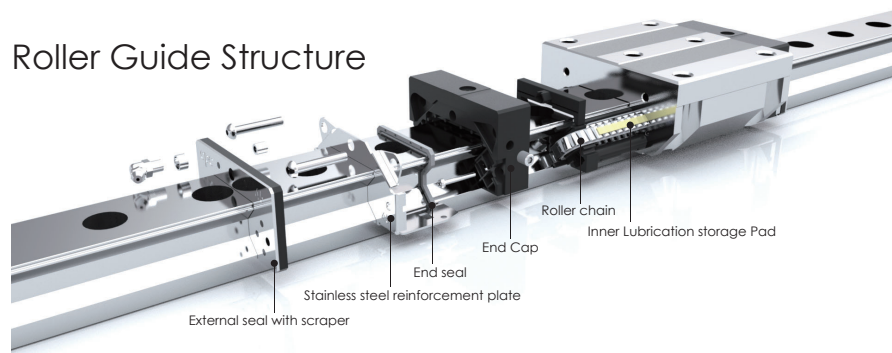

Travel speed : Reach V_{max} 10 m/s

Acceleration : Reach a_{max} 450 m/s²
Precondition: preload must be present, even when operating under load.

Types of the Roller Guide Block

ARR low profile Model

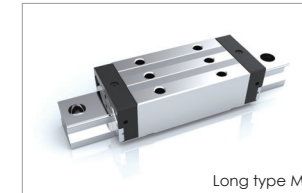
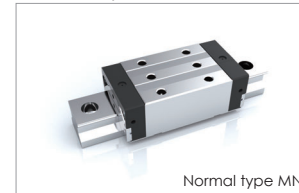

HRR standard profile Model

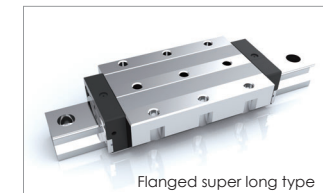
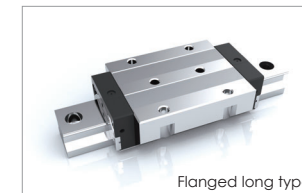
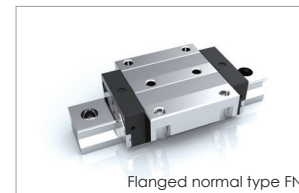
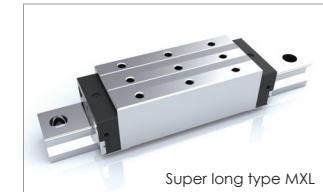
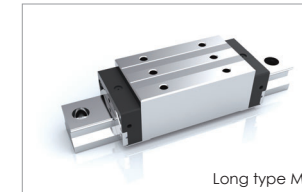
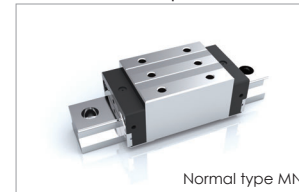

LRR low system height Model

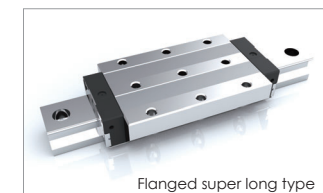
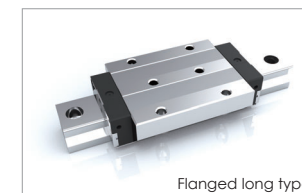
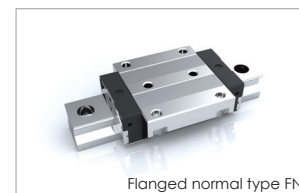
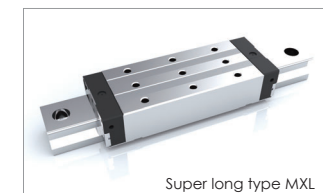
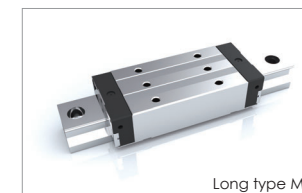

Roller Guide design

The LRR model with a lower system height

Compared with the other brands' standard, the model with a lower center of gravity is combined with a lower height can provide more compact height space, or for the applications that need to reduce external torque and smaller inertia force. ARR, HRR, and LRR blocks all share the same rail and have the same rated load and rated life.

Model specification				System height H
LRR	35	MN	FN	44
		ML	FL	
		MXL	FXL	
	45	MN	FN	52
		ML	FL	
		MXL	FXL	
55	MN	FN	63	
	ML	FL		
	MXL	FXL		

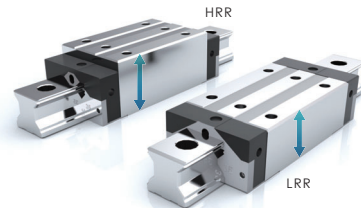
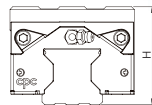

Space saving, compact design

MXL super long Block model

Compared with the other brands' ML extended slider, the longer-length super long block model can present greater rated load and rigidity, and has better vibration absorption. It is suitable for machine tools that require ultra-high rigidity and running accuracy.

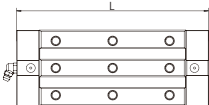

Model specification				Block length L
HRR	25			133.4
	35			177.5
	45	MXL	FXL	226
	55			290.4
LRR	35			177.5
	45	MXL	FXL	226
	55			290.4

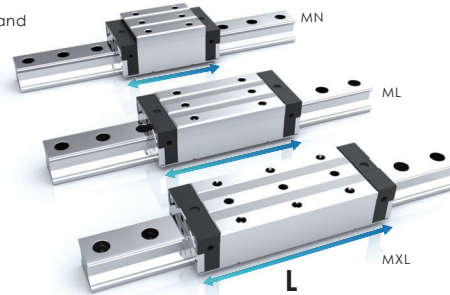

High load, high rigidity, super long design

Patented silent roller chain (option)

The roller chain can effectively reduce the high-frequency noise during the operation of the block and improve the running smoothness. The spacer in the roller chain between adjacent steel rollers can continuously replenish the oil film of the rollers to maintain better lubrication.

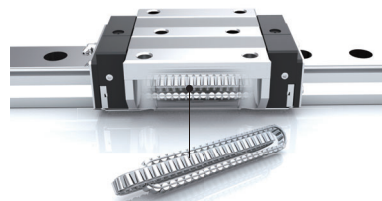

Improve the running smoothness, noise reduce design.

Built-in lubrication storage design (patent design)

The built-in PU lubrication storage is embedded in the revolving channel at both ends and the inner pipe of the block, which does not increase the length of the block, but can directly contact the rollers in each row. And according to the operating environment, the block is immersed in the lubricant, and the lubricant can also be injected through the inject port, so that enough lubricant is stored in the PU lubrication storage. This ensures the long-term lubrication effect and comply with environmental protection and reduction Maintenance cost.

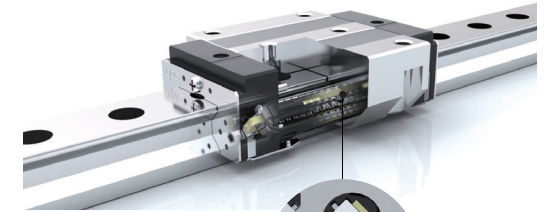

Excellent long-term lubrication effect, environmentally friendly design

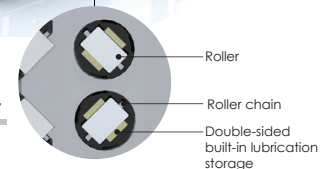

High-rigidity stainless steel reinforcement plate

The L-shaped design is fixed on the steel body of the block with screws on the end and bottom respectively; the bottom of the steel body is provided with an integrally formed milling tenon, which firmly locks the reinforcing sheet.

1. It can increase the strength of the plastic end cap and the ability to withstand high-speed operation, heavy load or harsh environment operation.
2. The gap between the reinforcement plate and the rail is 0.3mm max. It can completely obstruct the large foreign objects come into the block from the front side and protect the block from the damage of the metal chips.

Design in general



High speed impact, harsh environment, uncoated end caps which can easily damage the rotating end or stretched end caps.

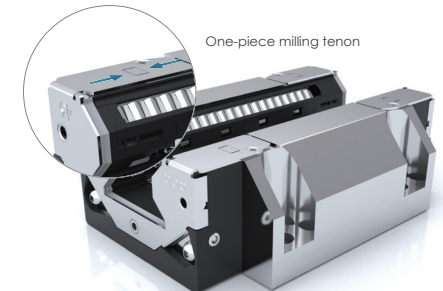

L-shaped high-rigidity protection design

Fully covered sealing design

The block of all models are equipped with contact-type "end seals", "bottom seals" and "inner seals". It can effectively prevent foreign particles, dust and wood chips from invading the block, and reduce the overflow of lubricating oil in the block.

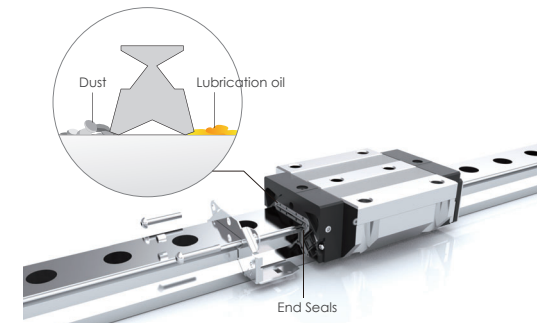
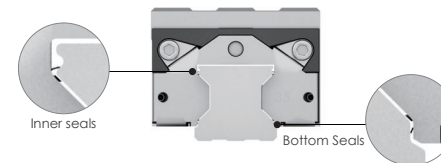

Fully sealed and dustproof design

Dust-proof design

Patented metal plastic cap (optional)

The upper part of the cap made of stainless steel can show excellent wear resistance in harsh environments. The inner side of the cap is equipped with a plastic fixed support part, which has the characteristics of easy installation. It can be directly installed on the standard rail. The support part contacts with the screw head screws to prevent by installation from beating too deeply; it can also prevent the cap is lowered due to the pressure of foreign matter above, causing foreign matter to accumulate, when the block moving.

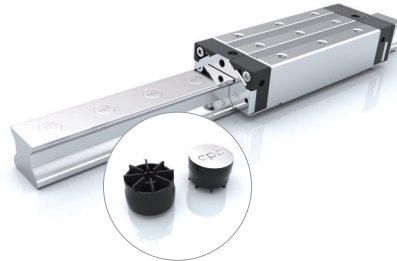

Easy installation, high wear resistance

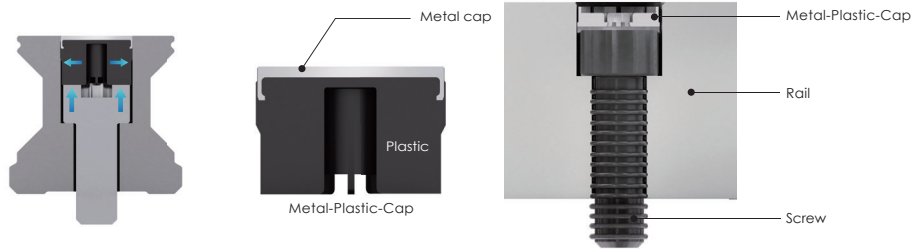

Dimensions and Specifications

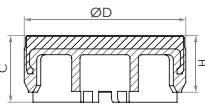

Model Code	Screw	External Diameter D (mm)	Cup Height H (mm)	Block Height C (mm)	Rail
A4	M4	7.7	1.7	2.0	ARR15
A5	M5	9.7	3.4	4.0	ARR20
A6	M6	11.3	2.9	3.5	ARR25
A8-R	M8	14.3	8.0	9.5	ARR35
A12	M12	20.4	5.0	5.6	ARR45
A14	M14	24.4	6.0	6.5	ARR55

External NBR seal with metal scraper (optional)

For environments where is full of fine dust, such as woodworking machines, glass processing machines, graphite processing machines, and grinders, it can show a high dust resistance. There is stainless steel scraper on the outside of the seal, and the gap between the inner profile and the rail profile is only 0.2-0.3mm, which can prevent large foreign objects from damaging the rubber seal.

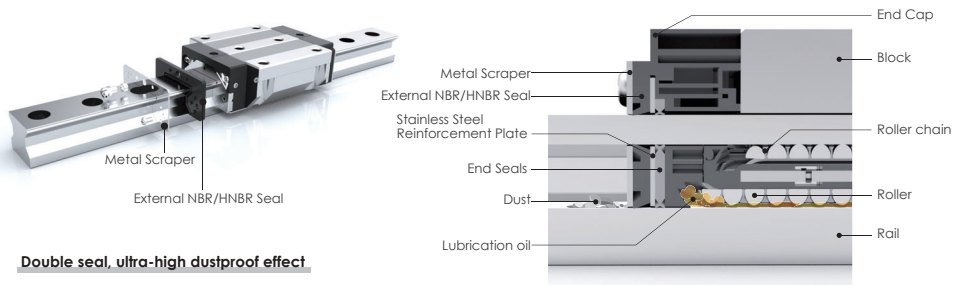

Double seal, ultra-high dustproof effect

Dust-proof design

Patented metal cover strip (optional)

The metal material can prevent foreign matter from invading harsh environments and has a super high dust-proof effect.

- Equipped with cover strip
- High dustproof effectiveness
- Easy installation
- Available in all sizes: 15-55
- Length of the cover strip will be the same as the guide rail
- Fixed device provided on both ends
- Under normal use, the metal cover can be installed and removed repeatedly

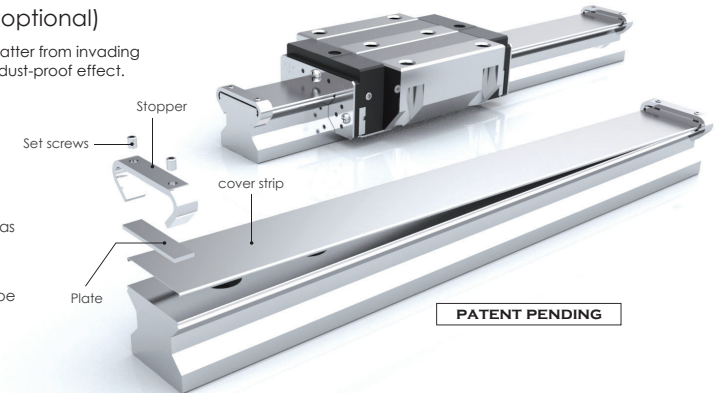

Easy installation, high dustproof effect

Metal cover strip installation

STEP 1.

Mounting the rail against the reference edge and tighten the screws; measuring the accuracy within the tolerance to ensure a correct mounting process.

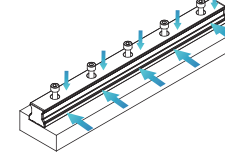

STEP 2.

1. Put the cover strip on one side of the rail.
2. Press down the cover strip on the other side to make it fit the rail.

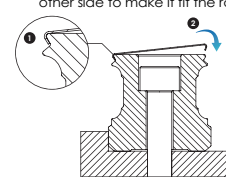

STEP 3.

The gap at both ends better to be the same.

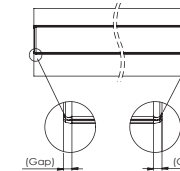

STEP 4.

1. Place the press plate on the cover strip.
2. Slide the metal stopper over the plate.
3. Tighten the screws slightly; the press plate is attached to the cover strip, the rounded surface is attached to the cover strip. Add some lubricating oil. Moving the stopper set forward to the other end by pushing the rigid block, thereafter fix on the rail top surface tightly.
4. Tighten the screws to fix the stopper on one end of the cover strip.

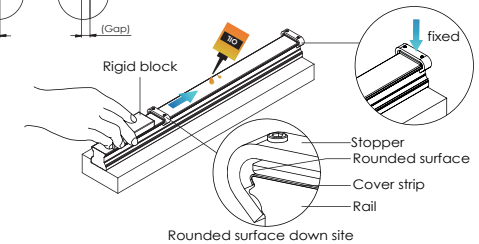

STEP 5.

Mounting the block onto the rail. "Attention the reference side on the right side."

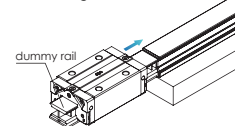

STEP 6.

After the block and the rail are assembled, fix the other stopper on the other end of the cover strip.

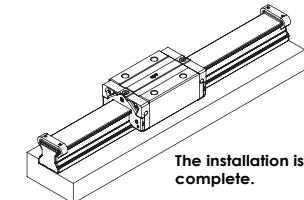
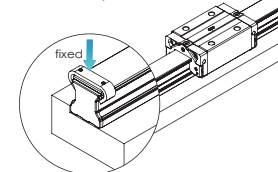

The installation is complete.

High rigidity and high load capacity

Roller guide super high load capacity ($C_{100 \text{ Roller}}$ VS $C_{100 \text{ Ball}}$)
 The load comparison value of each size of ball and roller block is shown in the chart. No matter in the N standard type, L long type and XL super long type, the load value of the roller is better. As shown in the chart, take size 55 as for example, the L long type of the roller is 36% higher than that of the ball long type, and the XL super long block is higher than the 22% of the L long type of the roller, achieving high torque and high load capacity.

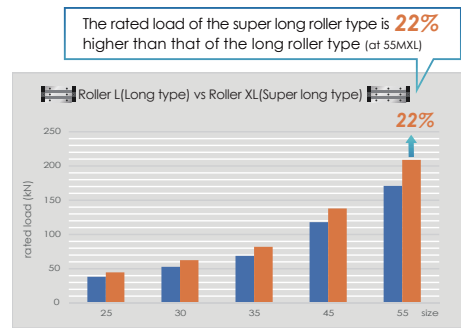
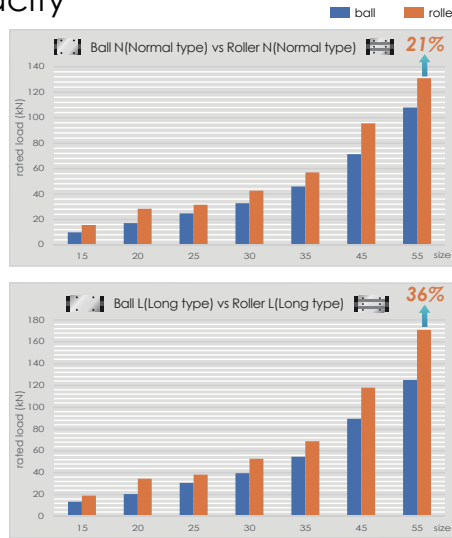

The service life of the roller guides significantly improved

When the equivalent load P is the same because the dynamic load rating of the roller type is larger, the service life is longer. Especially under light load conditions, the difference in service life between the roller type and the ball type can be highlighted.

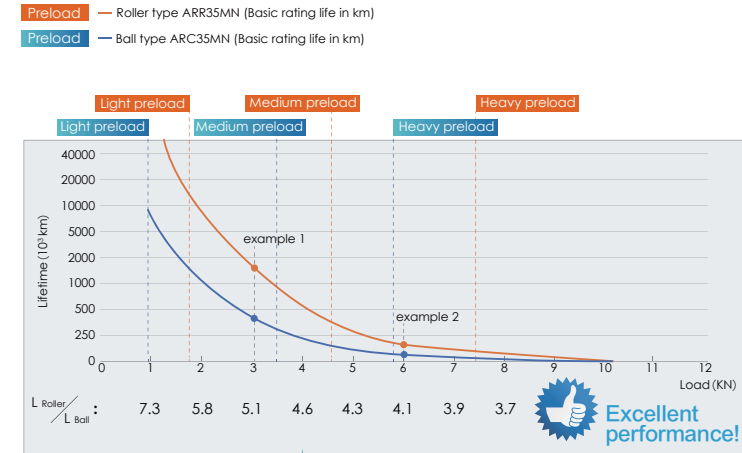

Roller guide ultra-high rigidity

The relationship between the deformation of the rolling element and the load is not linear. If the greater the deformation, the load will increase non-linearly, as shown in (Figure 1) on P13. As the load increases, the difference in the deformation of a roller and a ball becomes clear (Figure 2). The selection of preload must take into account the requirements of the installation equipment and devices. Generally speaking, the ratio between the selection of preload and the load value can be referred to as shown in Figures 3 and 4. When the load value exceeds F_{pm} , the preload of the rolling element in one direction will disappear, resulting in no preload. If you choose to work with preload, you should pay attention to the force condition under the maximum load to select the preload. However, excessive preload will reduce the service life and reduce the relubrication interval.

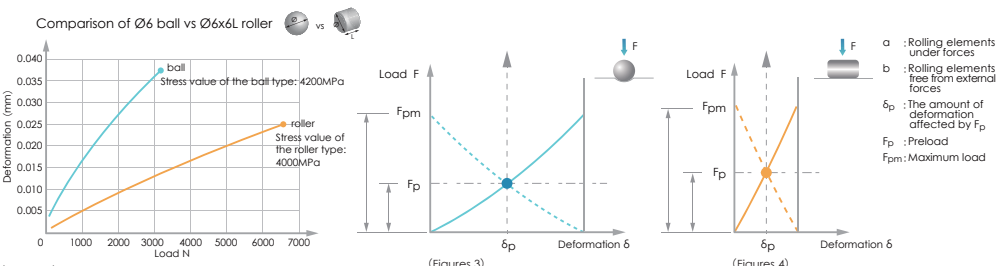

(Figures 2) * Ball type: The radius curvature ratio is 0.52 (when the load reaches static load capacity C_0 , the stress value is 4200MPa)
 * Roller type: When the load reaches static load capacity C_0 , the stress value is 4000MPa.

Compared to balls of the same size, the deformation of the rollers is not only less, but also the number of rolling elements that are loaded at the same time is larger than that of the balls, whereby the rollers present excellent high-precision performance. The right figure shows the result of the stiffness test with the load applied. The deformation of the roller is only 40-50% of the ball guide. (when a load of 40 kN).

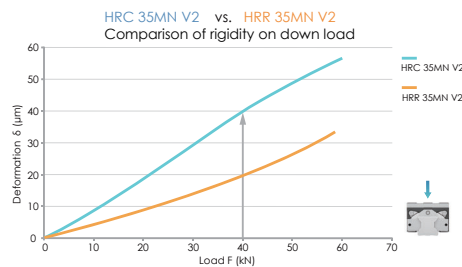

L_{Roller} = Basic rating life of roller linear guide
 L_{Ball} = Basic rating life of ball linear guide

Roller	ARR 35 MN	$C_{Roller} = 57000 \text{ N}$ $C_{0 \text{ Roller}} = 154000 \text{ N}$	Ball	ARC 35 MN	$C_{Ball} = 45900 \text{ N}$ $C_{0 \text{ Ball}} = 82900 \text{ N}$	C = Dynamic load rating N C_0 = Static load rating N L = Basic rating life km P = Equivalent load N
Calculation example 1: When P is 3000N		$\frac{C_{Roller}}{P} = 19$	$\frac{C_{Ball}}{P} = 15.3$	$L_{Roller} = (19)^{\frac{10}{3}} \cdot 10^2$	$L_{Ball} = (15.3)^{\frac{10}{3}} \cdot 10^2$	$L_{Roller} / L_{Ball} \approx 5.1$
Calculation example 2: When P is 6000N		$\frac{C_{Roller}}{P} = 9.5$	$\frac{C_{Ball}}{P} = 7.6$	$L_{Roller} = (9.5)^{\frac{10}{3}} \cdot 10^2$	$L_{Ball} = (7.6)^{\frac{10}{3}} \cdot 10^2$	$L_{Roller} / L_{Ball} \approx 4.1$

Roller guide accuracy grade

The ARR/HRR/LRR linear guides provide 4 different grades of precision : H, P, SP, and UP. Engineers can choose different grades depending on the machine applications.

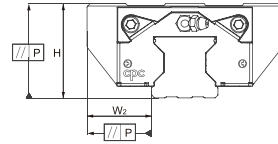

Size	Accuracy grades (µm)	UP	SP	P	H	
15 ~ 20	Tolerance of dimension height H	H	± 5	± 10	± 15	± 30
	Variation of height for different runner blocks on the same position of Rail	Δ H	3	5	6	10
	Tolerance of dimension width W ₂	W ₂	± 5	± 7	± 10	± 20
	Variation of width for different runner blocks on the same position of Rail	Δ W ₂	3	5	7	15
25 ~ 35	Tolerance of dimension height H	H	± 5	± 10	± 20	± 40
	Variation of height for different runner blocks on the same position of Rail	Δ H	3	5	7	15
	Tolerance of dimension width W ₂	W ₂	± 5	± 7	± 10	± 20
	Variation of width for different runner blocks on the same position of Rail	Δ W ₂	3	5	7	15
45 ~ 55	Tolerance of dimension height H	H	± 5	± 10	± 20	± 40
	Variation of height for different runner blocks on the same position of Rail	Δ H	3	5	7	15
	Tolerance of dimension width W ₂	W ₂	± 5	± 7	± 10	± 20
	Variation of width for different runner blocks on the same position of Rail	Δ W ₂	3	5	7	15

Runner block relative to linear guide, datum plane parallel motion precision

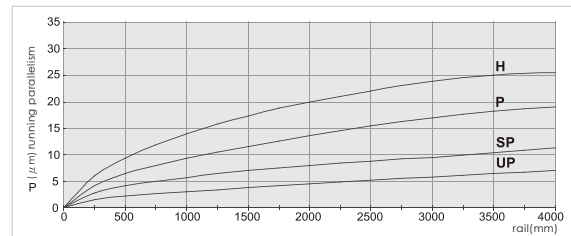

Roller guide preload and clearance

ARR/HRR/LRR			
Class	Description	Preload Value	Application
V0	Clearance	0.03C	For precision situations, smooth motion
V1	Medium Preload	0.08C	High stiffness, precision, high load situations
V2	Heavy Preload	0.13C	Super high stiffness, precision and load capacity

Major applications Selection of accuracy and preload

The table shows examples of accuracy grade and preload of linear guides for specific purposes. Refer to this table when selecting accuracy grade and preload type for your application.

Type of machine	Application	Accuracy grade				Preload and clearance		
		Precision class H	Precision class P	Precision class SP	Precision class UP	V0 Light Preload	V1 Medium Preload	V2 Heavy Preload
Machine tools	Machining centers		●	●			●	●
	Grinders			●	●		●	●
	Lathes		●	●			●	●
	Milling machines		●	●			●	●
	Drilling machines			●			●	●
	Tapping machines	●	●				●	●
	Laser cutting machines	●	●	●			●	●
Industrial machines and equipment	Electric discharge machines		●		●		●	●
	Press machines	●	●			●	●	
	Welding machines	●	●			●	●	
	Automatic spray painting machines	●				●		
	Automatic coil winding machines	●				●	●	
	Woodworking machines	●	●			●	●	
	Glass processing machines	●				●		
	Tire forming machines	●				●		
	Industrial robots	●	●			●	●	
	Materials handling equipment	●				●		
Semiconductor facilities	Probers			●		●	●	
	Wire bonders	●	●			●	●	
	PCB drillers	●	●			●	●	
	Dicing machine			●	●	●	●	
	Chip mounters	●	●			●	●	
Others	Mask Aligner			●	●	●	●	
	Measuring / inspection equipment	●	●	●	●	●	●	
	Three-dimensional measuring equipment	●	●	●	●	●	●	
	Medical equipment	●	●	●		●	●	
	Precision XY table	●	●	●		●	●	
	Injection molding machine	●					●	●
	OA equipment	●				●	●	●

Dimensions Table Rail (tapped from the bottom)

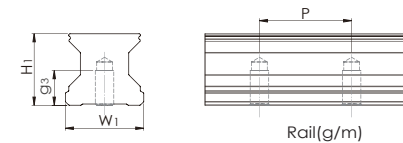

Model Code	W1	H1	P	Mxg3	Lmax	Mass (g/m)
ARRU 15	15	16.4	30	M5x8	4000	1500
ARRU 20	20	21	30	M6x10	4000	2400
ARRU 25	23	23	30	M6x12	4000	3000
ARRU 35	34	31	40	M8x15	4000	5740
ARRU 45	45	38	52.5	M12x19	4000	10000
ARRU 55	53	45	60	M14x24	4000	10000

Lubrication methods and precautions for roller guides

Function

When operating the linear guides under sufficient lubrication, a one-micron layer of the oil film at the contact zone separating the loaded rolling elements and the raceway.

Sufficient lubrication will:

- Reduce the friction
- Minimize wear
- Prevent oxidation
- Dissipate heat and increase operating life.

Lubrication methods and note on lubrication

- The block already contains lubricants that can be directly installed on the machine without additional cleaning.
- If cleaning of the block is required which the oil storage is equipped, please wait until the cleanser and clean naphtha in the oil storage are dry, and then put the block in lubricating oil, so that the oil storage can absorb enough lubricating oil before it will be installed in Machine.
- Before the first start-up, the carriage and the rail must be protected by adding lubricating grease and contact with liquid or solid contaminants must be avoided.
- The **cpc** block is provided with lubrication holes at the front and rear ends, as well as left and right and on the top. The grease can be injected into the block through the holes. The amount of grease required for a single block is given in the table below.
- The block must run back and forth while lubricating.
- Must consistently provide an oil film on the surface of the rail, which is easily noticeable optically.
- If dry and discolored, relubrication should be carried out immediately, and the relubrication interval should be determined according to the environment and conditions of use.
- The user must inform in advance if it is used in a cleanroom environment or requires acid and alkali resistance.
- If the use of a guide deviates from the horizontal installation, the use of oil lubrication must be carefully checked.
- The re-lubrication interval must be shortened if the travel stroke is < 2 or > 15 times the length of the steel body of the runner block.
- If the stroke is less than two times the steel body of the block, the grease must be injected through the lubrication hole from the left and right of the block and then run on a rail that is at least three times the length of the block to distribute the grease evenly in the block. Repeat this step twice.
- For the central lubrication system, **cpc** recommends the use of liquid grease NLGI 00 or NLGI 000.

Note on oil lubrication

- Please indicate "lubricating with oil: O" on order; the block will not be pre-lubricated with grease.
- If the block already has grease inside and the grease is different from the grease set by the customer or has exceeded the 12-month shelf life, you must clean the block before assembling. Test the lubricants to avoid grease incompatibility. Ensure that the channel is free, and the lubricant can flow to the rolling elements and be lubricated.
- If using the grease nipple combined with the tubing kit or the set screws for the lubricating oil inlet channel, must wrap it with a tapseal to achieve a leakproof effect.

Order code Description of the lubricant for the roller guide

Lubrication method	
Model Code	Description
No symbol	Grease is applied to the block. The amount of grease is for installation only. After installation, the customer must be filled with grease.
A	Only use anti-rust oil for primary treatment.
F	Fully lubricated, customers can install and use directly.
N	No grease, only with rust-proof paper packaging.
O	Use lubricant oil.

Note: If the customer orders lubrication storage Z, the lubrication storage will be soaked with lubricant oil (according to the order code) and then lubricated according to the lubrication mentioned

Lubricant code

Grease	
Model Code	Application
No symbol	Standard grease, lithium soap-based NLGI No.0, high-pressure and high-performance grease, suitable for general purpose.
A	For cleanroom application. Please contact cpc for cleanroom classes.
B	For the food and pharmaceutical processing industry
C	For heavy duty application
D	For short stroke application
E	Vacuum grease, please contact cpc for vacuum requirements.
F	Customer specified grease
Oil	
Model Code	Application
No symbol	VG 220 standard oil, suitable for general purpose. It is also used for cpc lubrication storage.
L	VG 68
M	VG 100
N	VG 150
P	For the food and pharmaceutical processing industry
Q	Vacuum grease, please contact cpc for vacuum requirements.
S	Customer specified grease

Ordering Information

Length of Rail

Butt-jointing is required when lengths exceed Lmax.
(For more detailed information, please contact **cpc** for technical support.)

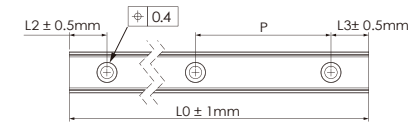

Model Code

ARR	U	35	M	N	S	2	Z	C	V1	P	-1480L	-20	-20	-O	-	II	/J
Customization code																	
Number of rails on the same moving axis																	
Lubricant: VG 220 (For detailed ordering code, please refer to P65 Grease Order model description)																	
Lubrication: oil (For detailed ordering code, please refer to P65 Grease Ordering Model Description)																	
End hole pitch(mm)																	
Starting hole pitch(mm)																	
Rail length(mm)																	
Accuracy grade: UP, SP, P, H																	
Preload class: V0, V1, V2																	
C: with roller chain																	
Z: with lubrication storage pad																	
Block quantity																	
Seal type: S: standard																	
Block length: N: standard L: long XL: extra long																	
Block width: M: standard F: flanged																	
Block type: 15 · 20 · 25 · 35 · 45 · 55																	
U: Rail (tapped from the bottom)																	
Product type: ARR: Low Profile Type HRR: High Profile Type LRR: Extremely Low Profile Type																	

Customization code(The meaning of suffix characters)

J : slide rail connection	R : special process for rail	SG : installation of side grease holes and set screws
G : customer designated lubricant	VD : customized designated preload pressure value	PC : with plastic caps for counter holes on the rail
I : with Inspection report	OA : block install with grease nipple by cpc (Please contact cpc for direction of grease nipple installation)	MPC : with Metal-Plastic Caps for rail mounting holes.
S : special straightness requirements for rail	DE : reference edges of block and rail on opposite sides	TR : bolt-Hole without chamfer
B : special processing for block	HN : external HNBR seal with metal scraper	RR : raydent coating treatment on the rail
BL : with extension and contraction support layer.	CR : clear chrome coating treatment on the rail	RB : raydent coating treatment on the block
SN : external NBR seal with metal scraper	CB : black chrome coating treatment on the block	RRB : raydent coating treatment on the block and rail
BR : black chrome coating treatment on the rail	CRB : clear chrome coating treatment on the block and rail	NB : nickel coating treatment on the block
BB : black chrome coating treatment on the block	NR : nickel coating treatment on the rail	
BRB : black chrome coating treatment on the block and rail		
SB : with stainless steel ball bearings		
NRB : nickel coating treatment on the block and rail		

Note: For special process or customized requirement, please contact **cpc** for more information.

* The end pitch of the rail should not exceed the 1/2 of original pitch, this is to avoid the misfit of the rail to the workbench.

Dimensions Table

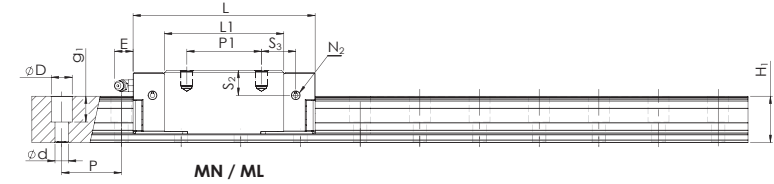
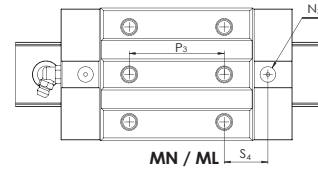
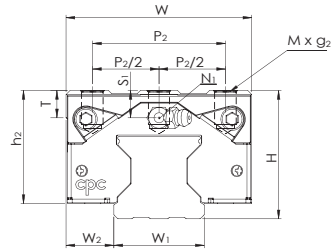

ARR MN/ML Series

Model Code	Mounting Dimensions		Rail Dimensions (mm)			Block Dimensions (mm)											Block Dimensions (mm)								Load Capacities (kN)				Static Moment (Nm)			Weight		Model Code
	H	W2	W1	H1	P	Dx dx g1	W	L	L1	h2	P1	P1/2	P2	P2/2	P3	M x G2	M1	T	N1	N2	N3	E	S1	S2	S3	S4	Ciso 100km	C0	Mr0	Mp0	My0	Block (g)	Rail (g/m)	
ARR 15MN	24	9.5	15	16.4	30	7.5x4.5x5.3	34	68.4	46	21.1	26	-	26	13	26	M4x7	-	8	M3x6	M3x4.5	P3	5.3	3.5	6.6	15	14	15.6	43	400	320	320	170	1500	ARR 15MN
ARR 15ML								83.4	61																22.5	21.5	19	55.3	530	560	560	230		
ARR 20MN	30	12	20	21	30	9.5x6x8.5	44	85.6	60	25.6	36	-	32	16	36	M5x8	-	9	M4x8	M4x6.5	P3	6	4.4	8.3	17	16.5	28.4	76.8	900	730	730	350	2400	ARR 20MN
ARR 20ML								106.6	81																20.5	20	35.5	102	1250	1300	1300	490		
ARR 25MN	36	12.5	23	23	30	11x7x9	48	95	67	31	35	-	35	17.5	35	M6x10	-	10	M6x8.5	M6x7.5	P4	12	6.5	11	21.4	20.5	31.6	84	1200	950	950	540	3000	ARR 25MN
ARR 25ML								114	86																23.4	22.5	38.3	108	1550	1550	1550	680		
ARR 35MN	48	18	34	31	40	14x9x17	70	122	84	42	50	-	50	25	50	M8x13	-	13	M6x12	M6x8	P5	12	10	16.4	25	25	57	154	2742	1946	1946	1200	5740	ARR 35MN
ARR 35ML								147.5	109.5																26.7	26.7	68.9	196	3525	3226	3226	1750		
ARR 45MN	60	20.5	45	38	52.5	20x14x17	86	156	110	52	60	-	60	30	60	M10x17	-	13	M6x12	M6x8	P6	12	14.6	21.8	39.2	36	95.9	255	6350	4450	4450	2600	10000	ARR 45MN
ARR 45ML								191	145																46.7	43.5	118	333	8450	7700	7700	3350		
ARR 55MN	70	23.5	53	45	60	24x16x20	100	182.4	130	60	75	-	75	37.5	75	M12x19	-	18	M6x12	M6x9	P6	12	15	22	41.5	39.7	131	338	9750	7100	7100	4500	12700	ARR 55MN
ARR 55ML								233.4	181																57	55.2	171	476	13900	13950	13950	5900		

- N2 = Injecting holes
- N3 = O-ring size for lubrication from above
- N2, N3 will be sealed before shipment, please open it when first using the product.
- Please refer to the catalog P11 for the size of the screw hole of the reinforcement sheet.

The above rating load capacities and static moments are calculated according to the ISO 14728 standard. The rating life for basic dynamic load ratings is defined as the total 100km travel distance for 90% of a group of identical linear guides, under the same conditions and free from any material damage caused by rolling fatigue.

ARR MN/ML...C Series (Roller chain type)

Model Code	Mounting Dimensions		Rail Dimensions (mm)			Block Dimensions (mm)											Block Dimensions (mm)								Load Capacities (kN)				Static Moment (Nm)			Weight		Model Code
	H	W2	W1	H1	P	Dx dx g1	W	L	L1	h2	P1	P1/2	P2	P2/2	P3	M x G2	M1	T	N1	N2	N3	E	S1	S2	S3	S4	Ccage 100km	C0	Mr0	Mp0	My0	Block (g)	Rail (g/m)	
ARR 15MN...C	24	9.5	15	16.4	30	7.5x4.5x5.3	34	68.4	46	21.1	26	-	26	13	26	M4x7	-	8	M3x6	M3x4.5	P3	5.3	3.5	6.6	15	14	19.5	36.8	360	280	280	170	1500	ARR 15MN...C
ARR 15ML...C								83.4	61																22.5	21.5	23.8	49.1	460	480	480	230		
ARR 20MN...C	30	12	20	21	30	9.5x6x8.5	44	85.6	60	25.6	36	-	32	16	36	M5x8	-	9	M4x8	M4x6.5	P3	6	4.4	8.3	17	16.5	35.5	65.8	840	670	670	350	2400	ARR 20MN...C
ARR 20ML...C								106.6	81																20.5	20	45	88	1100	1200	1200	490		
ARR 25MN...C	36	12.5	23	23	30	11x7x9	48	95	67	31	35	-	35	17.5	35	M6x10	-	10	M6x8.5	M6x7.5	P4	12	6.5	11	21.4	20.5	40	76	1100	850	850	540	3000	ARR 25MN...C
ARR 25ML...C								114	86																23.4	22.5	48	96	1360	1360	1360	680		
ARR 35MN...C	48	18	34	31	40	14x9x17	70	122	84	42	50	-	50	25	50	M8x13	-	13	M6x12	M6x8	P5	12	10	16.4	25	25	71.3	133	2350	1710	1710	1200	5740	ARR 35MN...C
ARR 35ML...C								147.5	109.5																26.7	26.7	86.1	175	3133	2881	2881	1750		
ARR 45MN...C	60	20.5	45	38	52.5	20x14x17	86	156	110	52	60	-	60	30	60	M10x17	-	13	M6x12	M6x8	P6	12	14.6	21.8	39.2	36	120	222	5750	4050	4050	2600	10000	ARR 45MN...C
ARR 45ML...C								191	145																46.7	43.5	147.5	288	7550	6900	6900	3350		
ARR 55MN...C	70	23.5	53	45	60	24x16x20	100	182.4	130	60	75	-	75	37.5	75	M12x19	-	18	M6x12	M6x9	P6	12	15	22	41.5	39.7	164	292	8600	6350	6350	4500	12700	ARR 55MN...C
ARR 55ML...C								233.4	181																57	55.2	214	415	12250	12300	12300	5900		

- N2 = Injecting holes
- N3 = O-ring size for lubrication from above
- N2, N3 will be sealed before shipment, please open it when first using the product.
- Please refer to the catalog P11 for the size of the screw hole of the reinforcement sheet.

The measured value is the dynamic load rating value with roller chain Ccage. The above static load rating and the static moment are calculated according to the ISO 14728 standard.

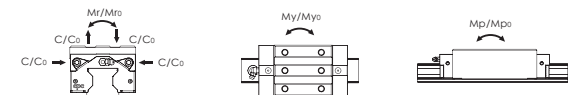

Dimensions Table

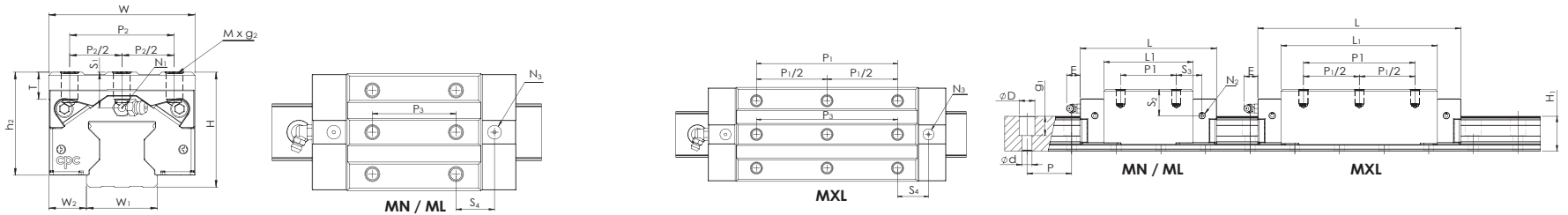

HRR MN/ML/MXL Series

Model Code	Mounting Dimensions			Rail Dimensions (mm)					Block Dimensions (mm)											Block Dimensions (mm)				Load Capacities (kN)				Static Moment (Nm)			Weight		Model Code		
	H	W ₂	W ₁ _{±0.05}	H ₁	P	D _x d _x g ₁	W	L	L ₁	h ₂	P ₁	P _{1/2}	P ₂	P _{2/2}	P ₃	M x G ₂	M ₁	T	N ₁	N ₂	N ₃	E	S ₁	S ₂	S ₃	S ₄	C _{iso} 100km	C ₀	M _{r0}	M _{p0}	M _{y0}	Block (g)		Rail (g/m)	
HRR 15MN	28	9.5	15	16.4	30	7.5x4.5x5.3	34	68.4	46	25.1	26	-	26	13	26	M4x8	-	8	M3x6	M3x4.5	P3	5.3	7.5	10.6	15	14	15.6	43	400	320	320	210	1500	HRR 15MN	
HRR 15ML								83.4	61		26	-	26		26																				HRR 15ML
HRR 20MN								85.6	60	29.6	36	-	32	16	36	M5x8	-	9	M4x8	M4x6.5	P3	6	8.4	12.3	17	16.5	28.4	76.8	900	730	730	420	2400	HRR 20MN	
HRR 20ML								106.6	81		50	-	50		50																			HRR 20ML	
HRR 25MN								95	67		35	-	35		35																			HRR 25MN	
HRR 25ML								114	86	35	50	-	35	17.5	50	M6x10	-	10	M6x8.5	M6x7.5	P4	12	10.5	15	23.4	22.5	38.3	108	1550	1550	1550	800	3000	HRR 25ML	
HRR 25MXL								133.4	105.4		70	-	35		70																			HRR 25MXL	
HRR 35MN								122	84		50	-			50																				HRR 35MN
HRR 35ML								147.5	109.5	49	72	-	50	25	72	M8x16	-	13	M6x12	M6x8	P5	12	17	23.4	26.7	26.7	68.9	196	3525	3226	3226	2100	5740	HRR 35ML	
HRR 35MXL								177.5	139.5		100	-	50		100																				HRR 35MXL
HRR 45MN								156	110		60	-			60																				HRR 45MN
HRR 45ML								191	145	62	80	-	60	30	80	M10x20	-	13	M6x12	M6x8	P6	12	24.6	31.8	46.7	43.5	118	333	8450	7700	7700	4300	10000	HRR 45ML	
HRR 45MXL								226	180		120	-	60		120																				HRR 45MXL
HRR 55MN								182.4	130		75	-			75																				HRR 55MN
HRR 55ML								233.4	181	70	95	-	75	37.5	95	M12x19	-	18	M6x12	M6x9	P6	12	25	32	57	55.2	171	476	13900	13950	13950	7400	12700	HRR 55ML	
HRR 55MXL								290.4	238		150	-	75		150																				HRR 55MXL

- N2 = Injecting holes
- N3 = O-ring size for lubrication from above
- N2, N3 will be sealed before shipment, please open it when first using the product.
- Please refer to the catalog P11 for the size of the screw hole of the reinforcement sheet.

The above rating load capacities and static moments are calculated according to the ISO 14728 standard. The rating life for a basic dynamic load ratings is defined as the total 100km travel distance for 90% of a group of identical linear guides, under the same conditions and free from any material damage caused by rolling fatigue.

HRR MN/ML/MXL Series...C Series (Roller chain type)

Model Code	Mounting Dimensions			Rail Dimensions (mm)					Block Dimensions (mm)											Block Dimensions (mm)				Load Capacities (kN)				Static Moment (Nm)			Weight		Model Code			
	H	W ₂	W ₁ _{±0.05}	H ₁	P	D _x d _x g ₁	W	L	L ₁	h ₂	P ₁	P _{1/2}	P ₂	P _{2/2}	P ₃	M x G ₂	M ₁	T	N ₁	N ₂	N ₃	E	S ₁	S ₂	S ₃	S ₄	C _{cage} 100km	C ₀	M _{r0}	M _{p0}	M _{y0}	Block (g)		Rail (g/m)		
HRR 15MN...C	28	9.5	15	16.4	30	7.5x4.5x5.3	34	68.4	46	25.1	26	-	26	13	26	M4x8	-	8	M3x6	M3x4.5	P3	5.3	7.5	10.6	15	14	19.5	36.8	360	280	280	210	1500	HRR 15MN...C		
HRR 15ML...C								83.4	61		26	-	26		26																					HRR 15ML...C
HRR 20MN...C								85.6	60	29.6	36	-	32	16	36	M5x8	-	9	M4x8	M4x6.5	P3	6	8.4	12.3	17	16.5	35.5	65.8	840	670	670	420	2400	HRR 20MN...C		
HRR 20ML...C								106.6	81		50	-	50		50																				HRR 20ML...C	
HRR 25MN...C								95	67		35	-	35		35																				HRR 25MN...C	
HRR 25ML...C								114	86	35	50	-	35	17.5	50	M6x10	-	10	M6x8.5	M6x7.5	P4	12	10.5	15	23.4	22.5	48	96	1360	1360	1360	800	3000	HRR 25ML...C		
HRR 25MXL...C								133.4	105.4		70	-	35		70																				HRR 25MXL...C	
HRR 35MN...C								122	84		50	-			50																				HRR 35MN...C	
HRR 35ML...C								147.5	109.5	49	72	-	50	25	72	M8x16	-	13	M6x12	M6x8	P5	12	17	23.4	26.7	26.7	86.1	175	3133	2881	2881	2100	5740	HRR 35ML...C		
HRR 35MXL...C								177.5	139.5		100	-	50		100																				HRR 35MXL...C	
HRR 45MN...C								156	110		60	-			60																				HRR 45MN...C	
HRR 45ML...C								191	145	62	80	-	60	30	80	M10x20	-	13	M6x12	M6x8	P6	12	24.6	31.8	46.7	43.5	147.5	288	7550	6900	6900	4300	10000	HRR 45ML...C		
HRR 45MXL...C								226	180		120	-	60		120																				HRR 45MXL...C	
HRR 55MN...C								182.4	130		75	-			75																				HRR 55MN...C	
HRR 55ML...C								233.4	181	70	95	-	75	37.5	95	M12x19	-	18	M6x12	M6x9	P6	12	25	32	57	55.2	214	415	12250	12300	12300	7400	12700	HRR 55ML...C		
HRR 55MXL...C								290.4	238		150	-	75		150																				HRR 55MXL...C	

- N2 = Injecting holes
- N3 = O-ring size for lubrication from above
- N2, N3 will be sealed before shipment, please open it when first using the product.
- Please refer to the catalog P11 for the size of the screw hole of the reinforcement sheet.

The measured value is the dynamic load rating value with roller chain C_{cage}. The above static load rating and the static moment are calculated according to the ISO 14728 standard.

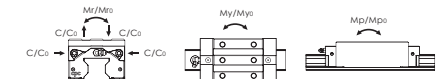

Dimensions Table

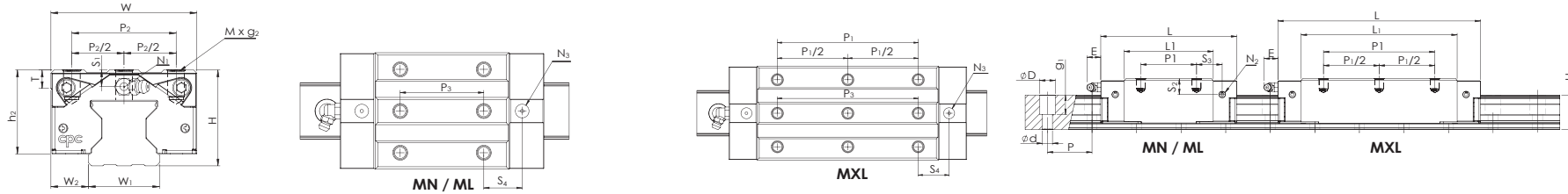

LRR MN/ML/MXL Series

Model Code	Mounting Dimensions		Rail Dimensions (mm)			Block Dimensions (mm)													Block Dimensions (mm)				Load Capacities (kN)				Static Moment (Nm)			Weight		Model Code						
	H	W2	W1 0.05	H1	P	Dx dxg1	W	L	L1	h2	P1	P1/2	P2	P2/2	P3	M x g2	M1	T	N1	N2	N3	E	S1	S2	S3	S4	Ciso 100km	C0	Mr0	Mpo	My0		Block (g)	Rail (g/m)				
LRR 35MN	44	18	34	31	40	14x9x17	70	122	84	38	72	-	50	25	72	M8x9	-	9	M6x12	M6x8	P5	12	6	12.4	25	25	57	154	2742	1946	1946	1100	5740	LRR 35MN				
LRR 35ML								147.5	109.5																									50	50	100	100	LRR 35ML
LRR 35MXL								177.5	139.5																									100	50	100	100	LRR 35MXL
LRR 45MN	52	20.5	45	38	52.5	20x14x17	86	156	110	44	80	-	60	30	80	M10x11	-	10	M6x12	M6x8	P6	12	6.6	13.8	39.2	36	95.9	255	6350	4450	4450	2100	10000	LRR 45MN				
LRR 45ML								191	145																									60	60	120	120	LRR 45ML
LRR 45MXL								226	180																									120	60	120	120	LRR 45MXL
LRR 55MN	63	23.5	53	45	60	24x16x20	100	182.4	130	53	95	-	75	37.5	75	M12x16	-	15	M6x12	M6x9	P6	12	8	15	41.5	39.7	131	338	9750	7100	7100	3800	12700	LRR 55MN				
LRR 55ML								233.4	181																									75	75	95	95	LRR 55ML
LRR 55MXL								290.4	238																									150	75	150	150	LRR 55MXL

- N2 = Injecting holes
- N3 = O-ring size for lubrication from above
- N2, N3 will be sealed before shipment, please open it when first using the product.
- Please refer to the catalog P11 for the size of the screw hole of the reinforcement sheet.

The above rating load capacities and static moments are calculated according to the ISO 14728 standard. The rating life for basic dynamic load ratings is defined as the total 100km travel distance for 90% of a group of identical linear guides, under the same conditions and free from any material damage caused by rolling fatigue.

LRR MN/ML/MXL Series...C Series (Roller chain type)

Model Code	Mounting Dimensions		Rail Dimensions (mm)			Block Dimensions (mm)													Block Dimensions (mm)				Load Capacities (kN)				Static Moment (Nm)			Weight		Model Code						
	H	W2	W1 0.05	H1	P	Dx dxg1	W	L	L1	h2	P1	P1/2	P2	P2/2	P3	M x g2	M1	T	N1	N2	N3	E	S1	S2	S3	S4	Ccage 100km	C0	Mr0	Mpo	My0		Block (g)	Rail (g/m)				
LRR 35MN...C	44	18	34	31	40	14x9x17	70	122	84	38	72	-	50	25	72	M8x9	-	9	M6x12	M6x8	P5	12	6	12.4	25	25	71.3	133	2350	1710	1710	1100	5740	LRR 35MN...C				
LRR 35ML...C								147.5	109.5																									50	50	100	100	LRR 35ML...C
LRR 35MXL...C								177.5	139.5																									100	50	100	100	LRR 35MXL...C
LRR 45MN...C	52	20.5	45	38	52.5	20x14x17	86	156	110	44	80	-	60	30	80	M10x11	-	10	M6x12	M6x8	P6	12	6.6	13.8	39.2	36	120	222	5750	4050	4050	2100	10000	LRR 45MN...C				
LRR 45ML...C								191	145																									60	60	120	120	LRR 45ML...C
LRR 45MXL...C								226	180																									120	60	120	120	LRR 45MXL...C
LRR 55MN...C	63	23.5	53	45	60	24x16x20	100	182.4	130	53	95	-	75	37.5	75	M12x16	-	15	M6x12	M6x9	P6	12	8	15	41.5	39.7	164	292	8600	6350	6350	3800	12700	LRR 55MN...C				
LRR 55ML...C								233.4	181																									75	75	95	95	LRR 55ML...C
LRR 55MXL...C								290.4	238																									150	75	150	150	LRR 55MXL...C

- N2 = Injecting holes
- N3 = O-ring size for lubrication from above
- N2, N3 will be sealed before shipment, please open it when first using the product.
- Please refer to the catalog P11 for the size of the screw hole of the reinforcement sheet.

The measured value is the dynamic load rating value with roller chain Ccage. The above static load rating and the static moment are calculated according to the ISO 14728 standard.

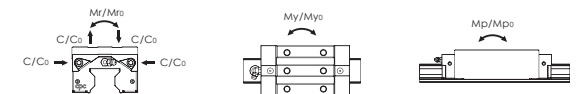

Dimensions Table

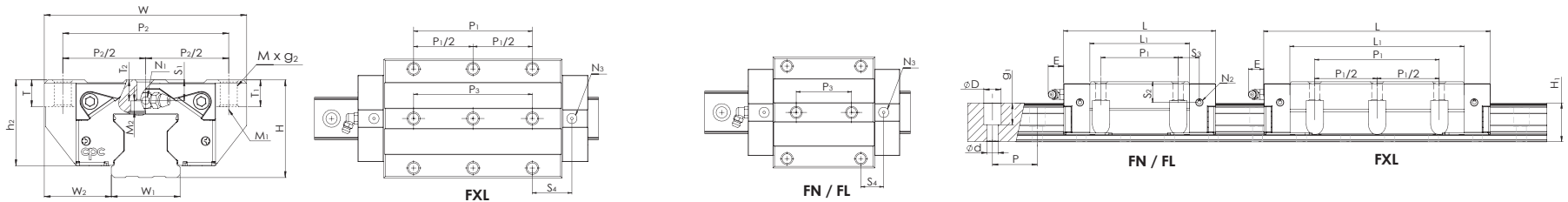

HRR FN/FL/FXL Series

Model Code	Mounting Dimensions		Rail Dimensions (mm)					Block Dimensions (mm)										Block Dimensions (mm)							Load Capacities (kN)				Static Moment (Nm)			Weight		Model Code					
	H	W ₂	W _{1 0/0.05}	H ₁	P	Dx dxg ₁	W	L	L ₁	h ₂	P ₁	P _{1/2}	P ₂	P _{2/2}	P ₃	Mxg ₂	M ₁	M ₂	T	T ₁	T ₂	N ₁	N ₂	N ₃	E	S ₁	S ₂	S ₃	S ₄	C _{iso 100km}	C ₀	M _{ro}	M _{po}		M _{yo}	Block (g)	Rail (g/m)		
HRR 15FN	24	16	15	16.4	30	7.5x4.5x5.3	47	68.4	46	21.1	30	-	38	19	26	M5x7	M4	2.8	8	7	4	M3x6	M3x4.5	P3	5.3	3.5	6.6	13	12	15.6	43	400	320	320	230	1500	HRR 15FN		
HRR 15FL								83.4	61																														HRR 15FL
HRR 20FN	30	21.5	20	21	30	9.5x6x8.5	63	85.6	60	25.6	40	-	53	26.5	35	M6x10	M5	3.5	10	10	4.8	M4x8	M4x6.5	P3	6	4.4	8.3	15	14.5	28.4	76.8	900	730	730	490	2400	HRR 20FN		
HRR 20FL								106.6	81																													HRR 20FL	
HRR 25FN								95	67		45	-	-	-	-	M8x10	M6	4	10	10	8.3	M6x8.5	M6x7.5	P4	12	6.5	11	16.4	15.5	31.6	84	1200	950	950	750	3000	HRR 25FN		
HRR 25FL	36	23.5	23	23	30	11x7x9	70	114	86	31	70	35	-	57	28.5	40	M8x10	M6	4	10	10	8.3	M6x8.5	M6x7.5	P4	12	6.5	11	25.9	25	38.3	108	1550	1550	1550	960	2400	HRR 25FL	
HRR 25FXL								133.4	105.4		70	35	-	-	-																							HRR 25FXL	
HRR 35FN								122	84		62	-	-	-	52	M10x13	M8	5	13	13	10.2	M6x12	M6x8	P5	12	10	16.4	19	19	57	154	2742	1946	1946	1700	5740	HRR 35FN		
HRR 35FL	48	33	34	31	40	14x9x17	100	147.5	109.5	42	62	-	82	41																								HRR 35FL	
HRR 35FXL								177.5	139.5		100	50	-	-	100																								HRR 35FXL
HRR 45FN								156	110		80	-	-	-	60	M12x15	M10	6	15	15	14.8	M6x12	M6x8	P6	12	14.6	21.8	29.2	26	95.9	255	6350	4450	4450	3600	10000	HRR 45FN		
HRR 45FL	60	37.5	45	38	52.5	20x14x17	120	191	145	52	80	-	100	50	60																							HRR 45FL	
HRR 45FXL								226	180		120	60	-	-	120																								HRR 45FXL
HRR 55FN								182.4	130		95	-	-	-	70	M14x18	M12	7	18	18	16.8	M6x12	M6x9	P6	12	15	22	31.5	29.7	131	338	9750	7100	7100	6000	12700	HRR 55FN		
HRR 55FL	70	43.5	53	45	60	24x16x20	140	233.4	181	60	95	-	116	58	70																							HRR 55FL	
HRR 55FXL								290.4	238		150	75	-	-	150																								HRR 55FXL

- N2 = Injecting holes
- N3 = O-ring size for lubrication from above
- N2, N3 will be sealed before shipment, please open it when first using the product.

- Mxg², M1: Screw size according to ISO 4762-12.9
- M₂ countersunk screw size according to DIN 7984-8.8
- Please refer to the catalog P11 for the size of the screw hole of the reinforcement sheet.

The above rating load capacities and static moments are calculated according to the ISO14728 standard. The rating life for basic dynamic load ratings is defined as the total 100km travel distance for 90% of a group of identical linear guides, under the same conditions and free from any material damage caused by rolling fatigue.

HRR FN/FL/FXL Series...C Series (Roller chain type)

Model Code	Mounting Dimensions		Rail Dimensions (mm)					Block Dimensions (mm)										Block Dimensions (mm)							Load Capacities (kN)				Static Moment (Nm)			Weight		Model Code						
	H	W ₂	W _{1 0/0.05}	H ₁	P	Dx dxg ₁	W	L	L ₁	h ₂	P ₁	P _{1/2}	P ₂	P _{2/2}	P ₃	Mxg ₂	M ₁	M ₂	T	T ₁	T ₂	N ₁	N ₂	N ₃	E	S ₁	S ₂	S ₃	S ₄	C _{cage 100km}	C ₀	M _{ro}	M _{po}		M _{yo}	Block (g)	Rail (g/m)			
HRR 15FN...C	24	16	15	16.4	30	7.5x4.5x5.3	47	68.4	46	21.1	30	-	38	19	26	M5x7	M4	2.8	8	7	4	M3x6	M3x4.5	P3	5.3	3.5	6.6	13	12	19.5	36.8	360	280	280	230	1500	HRR 15FN...C			
HRR 15FL...C								83.4	61																															HRR 15FL...C
HRR 20FN...C	30	21.5	20	21	30	9.5x6x8.5	63	85.6	60	25.6	40	-	53	26.5	35	M6x10	M5	3.5	10	10	4.8	M4x8	M4x6.5	P3	6	4.4	8.3	15	14.5	35.5	65.8	840	670	670	490	2400	HRR 20FN...C			
HRR 20FL...C								106.6	81		40	-	53	26.5	35																								HRR 20FL...C	
HRR 25FN...C								95	67		45	-	-	-	-	M8x10	M6	4	10	10	8.3	M6x8.5	M6x7.5	P4	12	6.5	11	16.4	16.4	40	76	1100	850	850	750	3000	HRR 25FN...C			
HRR 25FL...C	36	23.5	23	23	30	11x7x9	70	114	86	31	70	35	-	57	28.5	40	M8x10	M6	4	10	10	8.3	M6x8.5	M6x7.5	P4	12	6.5	11	25.9	25	48	96	1360	1360	1360	960	2400	HRR 25FL...C		
HRR 25FXL...C								133.4	105.4		70	35	-	-	-																								HRR 25FXL...C	
HRR 35FN...C								122	84		62	-	-	-	52	M10x13	M8	5	13	13	10.2	M6x12	M6x8	P5	12	10	16.4	19	19	71.3	133	2350	1710	1710	1700	5740	HRR 35FN...C			
HRR 35FL...C	48	33	34	31	40	14x9x17	100	147.5	109.5	42	62	-	82	41																									HRR 35FL...C	
HRR 35FXL...C								177.5	139.5		100	50	-	-	100																									HRR 35FXL...C
HRR 45FN...C								156	110		80	-	-	-	60	M12x15	M10	6	15	15	14.8	M6x12	M6x8	P6	12	14.6	21.8	29.2	26	120	222	5750	4050	4050	3600	10000	HRR 45FN...C			
HRR 45FL...C	60	37.5	45	38	52.5	20x14x17	120	191	145	52	80	-	100	50	60																								HRR 45FL...C	
HRR 45FXL...C								226	180		120	60	-	-	120																									HRR 45FXL...C
HRR 55FN...C								182.4	130		95	-	-	-	70	M14x18	M12	7	18	18	16.8	M6x12	M6x9	P6	12	15	22	31.5	29.7	164	307	8600	6350	6350	6000	12700	HRR 55FN...C			
HRR 55FL...C	70	43.5	53	45	60	24x16x20	140	233.4	181	60	95	-	116	58	70																								HRR 55FL...C	
HRR 55FXL...C								290.4	238		150	75	-	-	150																									HRR 55FXL...C

- N2 = Injecting holes
- N3 = O-ring size for lubrication from above
- N2, N3 will be sealed before shipment, please open it when first using the product.

- Mxg², M1: Screw size according to ISO 4762-12.9
- M₂ countersunk screw size according to DIN 7984-8.8
- Please refer to the catalog P11 for the size of the screw hole of the reinforcement sheet.

The measured value is the dynamic load rating value with roller chain C_{cage}. The above static load rating and the static moment are calculated according to the ISO 14728 standard.

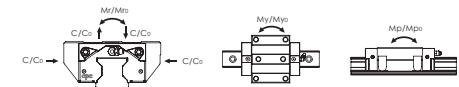

Dimensions Table

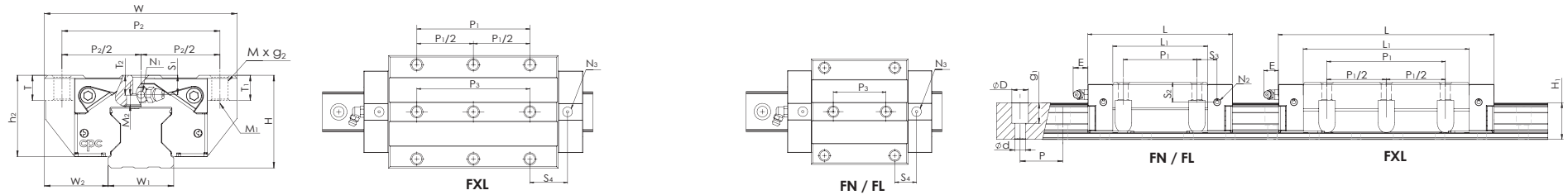

LRR FN/FL/FXL Series

Model Code	Mounting Dimensions		Rail Dimensions (mm)				Block Dimensions (mm)													Block Dimensions (mm)								Load Capacities (kN)		Static Moment (Nm)			Weight		Model Code		
	H	W ₂	W ₁ _{±0.005}	H ₁	P	D _x d _x g ₁	W	L	L ₁	h ₂	P ₁	P ₁ /2	P ₂	P ₂ /2	P ₃	M _x G ₂	M ₁	M ₂	T	T ₁	T ₂	N ₁	N ₂	N ₃	E	S ₁	S ₂	S ₃	S ₄	C _{iso} 100km	C ₀	M _{ro}	M _{po}	M _{yo}		Block (g)	Rail (g/m)
LRR 35FN	44	33	34	31	40	14x9x17	100	122	84	38	62	-	82	41	52	M10x13	M8	5	9	13	6.7	M6x12	M6x8	P5	12	6	12.4	19	19	57	154	2742	1946	1946	1550	5740	LRR 35FN
LRR 35FL							147.5	109.5	100	50	100	27.7	27.7	82	245													4439	5111	5111	2800	LRR 35FL					
LRR 35FXL							177.5	139.5	100	50	100	27.7	27.7	82	245													4439	5111	5111	2800	LRR 35FXL					
LRR 45FN	52	37.5	45	38	52.5	20x14x17	120	156	110	44	80	-	100	50	60	M12x15	M10	6	10	15	7.3	M6x12	M6x8	P6	12	6.6	13.8	29.2	26	95.9	255	6350	4450	4450	2900	10000	LRR 45FN
LRR 45FL							191	145	120	60	120	46.7	43.5	118	333													8450	7700	7700	3800	LRR 45FL					
LRR 45FXL							226	180	120	60	120	46.7	43.5	118	333													8450	7700	7700	3800	LRR 45FXL					
LRR 55FN	63	43.5	53	45	60	24x16x20	140	182.4	130	53	95	-	116	58	70	M14x18	M12	7	15	18	9.8	M6x12	M6x9	P6	12	8	15	31.5	29.7	131	338	9750	7100	7100	5200	12700	LRR 55FN
LRR 55FL							233.4	181	140	60	140	57	55.2	171	476													13900	13950	13950	7100	LRR 55FL					
LRR 55FXL							290.4	238	140	60	140	57	55.2	171	476													13900	13950	13950	7100	LRR 55FXL					

- N₂ = Injecting holes
- N₃ = O-ring size for lubrication from above
- N₂, N₃ will be sealed before shipment, please open it when first using the product.

- M_xG₂, M₁: Screw size according to ISO 4762-12.9
- M₂ countersunk screw size according to DIN 7984-8.8
- Please refer to the catalog P11 for the size of the screw hole of the reinforcement sheet.

The above rating load capacities and static moments are calculated according to the ISO14728 standard. The rating life for basic dynamic load ratings is defined as the total 100km travel distance for 90% of a group of identical linear guides, under the same conditions and free from any material damage caused by rolling fatigue.

LRR FN/FL/FXL Series...C Series (Roller chain type)

Model Code	Mounting Dimensions		Rail Dimensions (mm)				Block Dimensions (mm)													Block Dimensions (mm)								Load Capacities (kN)		Static Moment (Nm)			Weight		Model Code		
	H	W ₂	W ₁ _{±0.005}	H ₁	P	D _x d _x g ₁	W	L	L ₁	h ₂	P ₁	P ₁ /2	P ₂	P ₂ /2	P ₃	M _x G ₂	M ₁	M ₂	T	T ₁	T ₂	N ₁	N ₂	N ₃	E	S ₁	S ₂	S ₃	S ₄	C _{cage} 100km	C ₀	M _{ro}	M _{po}	M _{yo}		Block (g)	Rail (g/m)
LRR 35FN...C	44	33	34	31	40	14x9x17	100	122	84	38	62	-	82	41	52	M10x13	M8	5	9	13	6.7	M6x12	M6x8	P5	12	6	12.4	19	19	71.3	133	2350	1710	1710	1550	5740	LRR 35FN...C
LRR 35FL...C							147.5	109.5	100	50	100	27.7	27.7	102.5	224													4047	4695	4695	2800	LRR 35FL...C					
LRR 35FXL...C							177.5	139.5	100	50	100	27.7	27.7	102.5	224													4047	4695	4695	2800	LRR 35FXL...C					
LRR 45FN...C	52	37.5	45	38	52.5	20x14x17	120	156	110	44	80	-	100	50	60	M12x15	M10	6	10	15	7.3	M6x12	M6x8	P6	12	6.6	13.8	29.2	26	120	222	5750	4050	4050	2900	10000	LRR 45FN...C
LRR 45FL...C							191	145	120	60	120	46.7	43.5	147.5	288													7550	6900	6900	3800	LRR 45FL...C					
LRR 45FXL...C							226	180	120	60	120	46.7	43.5	147.5	288													7550	6900	6900	3800	LRR 45FXL...C					
LRR 55FN...C	63	43.5	53	45	60	24x16x20	140	182.4	130	53	95	-	116	58	70	M14x18	M12	7	15	18	9.8	M6x12	M6x9	P6	12	8	15	31.5	29.7	164	307	8600	6350	6350	5200	12700	LRR 55FN...C
LRR 55FL...C							233.4	181	140	60	140	57	55.2	214	430													12200	12300	12300	7100	LRR 55FL...C					
LRR 55FXL...C							290.4	238	140	60	140	57	55.2	214	430													12200	12300	12300	7100	LRR 55FXL...C					

- N₂ = Injecting holes
- N₃ = O-ring size for lubrication from above
- N₂, N₃ will be sealed before shipment, please open it when first using the product.

- M_xG₂, M₁: Screw size according to ISO 4762-12.9
- M₂ countersunk screw size according to DIN 7984-8.8
- Please refer to the catalog P11 for the size of the screw hole of the reinforcement sheet.

The measured value is the dynamic load rating value with roller chain C_{cage}. The above static load rating and the static moment are calculated according to the ISO 14728 standard.

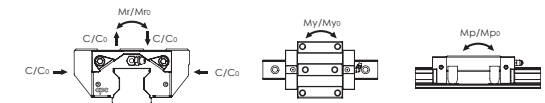

Bellows

Type of bellows

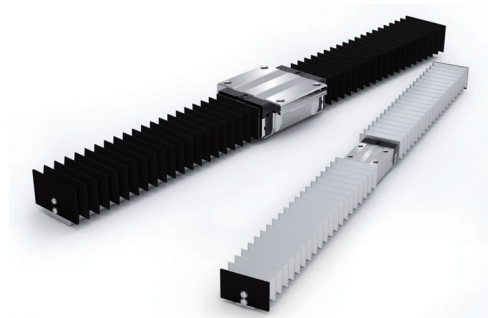

Nylon waterproof bellow (black)
Features: protection against water, oil and dust

Teflon glass fiber bellow (brown)
Features: fireproof, acid and alkali resistance

Antistatic fabric bellow (light blue)
Properties: especially for cleanrooms
(only antistatic detection, no dust detection)

Neoprene rubber bellow (black)
Features: oil and water resistance

PVC nylon waterproof bellow (black)
Features: waterproof, oil-proof, dust-proof

Aluminum-plated fireproof bellow (bright silver)
Features: non flammable, waterproof, oil-proof

Fixing with block

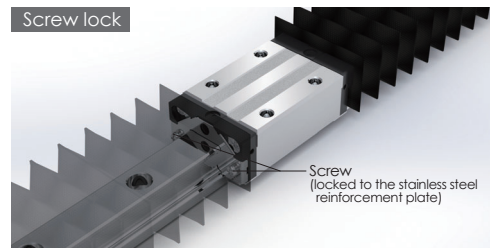

Screw lock

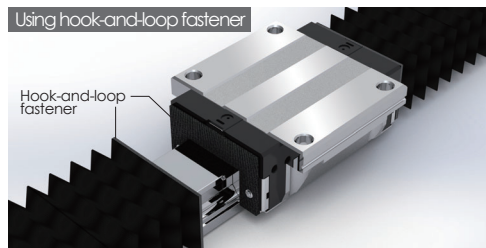

Using hook-and-loop fastener

Calculations

$$L_{min} = \frac{S}{(Q-1)}$$

S: Stroke (mm)

EX:

S = 200 size: HRC 20 Q = 6 Lmax = 40 x 6 = 240
Lmax / Lmin = 240 / 40

Lmax = Lmin * Q Q: Calculation factor

$$L_{min} = \frac{200}{(6-1)} = 40$$

Lmin : 10mm

Ordering information

HRC	20	BL-C	240 / 40
			Lmax / Lmin (mm)
Bellows:			
		BL-A Nylon waterproof bellow	BL-D Neoprene rubber bellow
		BL-B Teflon glass fiber bellow	BL-E PVC nylon waterproof bellow
		BL-C Antistatic fabric bellow	BL-F Aluminum-plated fireproof bellow
type : Standard Ball type: 15, 20, 25, 30, 35, 45, 55 Wide Ball type: 21/15, 27/20 Standard Roller type: 35, 45			
Product type : Standard Ball type: ARC / HRC / ERC Wide Ball type: WRC Standard Roller type: ARR / HRR / LRR			

Ordering example : HRC20-BL-C-240/40

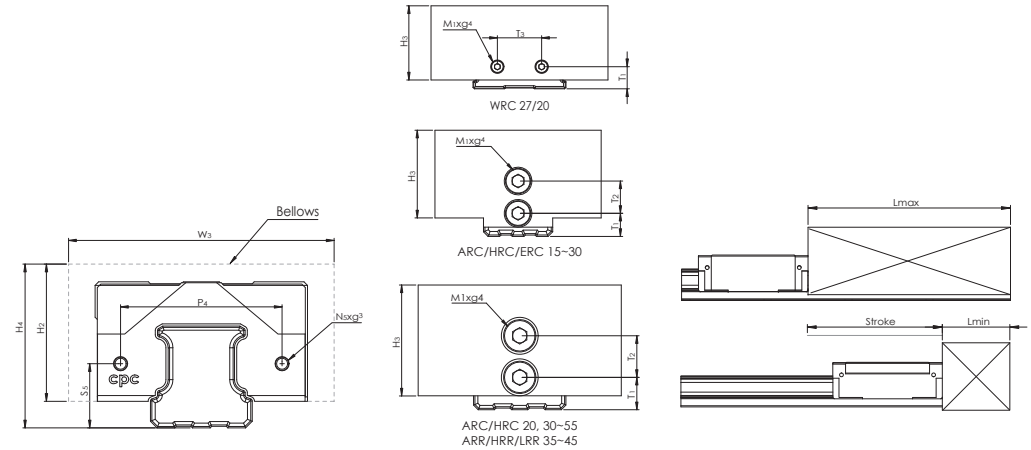

Dimensions and Specifications

Applicable to: Nylon waterproof bellow, Teflon glass fiber bellow and Antistatic fabric bellow

Type	Size	Main dimensions				Screw holes on the block		fastening screw for block		Screw holes on the rail			fastening screw for rail	calculation factor
		W3	H2	H3	H4	P4	S5	N5	g3	T1	T2	T3	M1xg4	Q
ARC/HRC/ERC	15	36	19	19	23	25	9.4	M3x0.35	2.3	5	7	-	M3x6	5
	20	44	21	21	27	29	12.5	M3x0.35	2.1	7	9	-	M4x8	6
	25	50	25	25	32	36.5	14.5	M3x0.35	2.8	9	9	-	M4x8	7
	30	60	34	34	41	42.5	17	M4x0.5	3.2	10	10	-	M4x8	8
	35	70	39	39	47	50	19.5	M4x0.5	3.1	13	10	-	M4x8	9
	45	86	49	49	59	65	24	M4x0.5	5.8	15	13	-	M5x10	10
55	100	56	56	69	73	28.5	M5x0.5	5.6	18	15	-	M5x10	12	
WRC	27/20	72	22	22	26	50	11	M3x0.35	2.5	10	-	20	M3x6	5
ARR/HRR/LRR	35	80	36	36	43	60	18	M4x0.5	4.7	13	10	-	M4x8	12
	45	95	42	42	51	70	22.5	M4x0.5	3.3	15	13	-	M5x10	14

Applicable to: PVC nylon waterproof bellow, Aluminum-plated fireproof bellow, Neoprene rubber bellow (please pay attention to the height of the bellow when selecting)

Type	Size	Main dimensions				Screw holes on the block		fastening screw for block		Screw holes on the rail			fastening screw for rail	calculation factor
		W3	H2	H3	H4	P4	S5	N5	g3	T1	T2	T3	M1xg4	Q
ARC/HRC/ERC	15	55	27	27	31	25	9.4	M3x0.35	2.3	5	7	-	M3x6	5
	20	60	32	32	38	29	12.5	M3x0.35	2.1	7	9	-	M4x8	6
	25	69	37	37	44	36.5	14.5	M3x0.35	2.8	9	9	-	M4x8	7
	30	80	44	44	51	42.5	17	M4x0.5	3.2	10	10	-	M4x8	8
	35	90	50	50	58	50	19.5	M4x0.5	3.1	13	10	-	M4x8	9
	45	105	57	57	67	65	24	M4x0.5	5.8	15	13	-	M5x10	10
55	125	66	66	79	73	28.5	M5x0.5	5.6	18	15	-	M5x10	12	
ARR/HRR/LRR	35	84	47	47	54	60	18	M4x0.5	4.7	13	10	-	M4x8	8
	45	112	60	60	69	70	22.5	M4x0.5	3.3	15	13	-	M5x10	11

* If any customized requirements, please contact cpc.

Nipple Option

Grease nipple/ Oil piping joint

OB-M3-M6	OA-M3-D4	OA-M6-M8	OA-M6-PT1/8	
OA-M6-G1/8	OB-M6-M8	OB-M6-PT1/8	OA-PT1/8-M8	
Ø 6 Oil hole grease injector available	Ø 4 Oil hole grease injector available	Ø 4 Oil hole grease injector available	Ø 4 Oil hole grease injector available	
OA-PT1/8-PT1/8	OA-PT1/8-G1/8	OB-PT1/8-M8	OB-PT1/8-PT1/8	
	Ø 6 Oil hole grease injector available	Ø 4 Oil hole grease injector available		

- The L type nipple is for both ball bearing and roller type external seals (SN)
- The XL type nipple is for the roller type external seal (SN)

Note: in case of need for customization or special requirements, please contact **cpc**

B-M6-XL	OA-M6-M8-L	OA-M6-PT1/8-L	OA-M6-G1/8-L	
OB-M6-M8-L	OB-M6-PT1/8-L	B-PT1/8-L	OA-M6-M8-XL	
Ø 4 Oil hole grease injector available	Ø 4 Oil hole grease injector available	Ø 4 Oil hole grease injector available	Ø 4 Oil hole grease injector available	
OA-M6-PT1/8-XL	OA-M6-G1/8-XL	OB-M6-M8-XL	OB-M6-PT1/8-XL	
	Ø 6 Oil hole grease injector available	Ø 4 Oil hole grease injector available		

Lubrication Kit and Grease Gun

The **cpc** Lubrication Unit is a supply nozzle with 3 different sizes of nozzle adaptors. These nozzle adaptors are suitable for differently sized grease nipples on different sized linear blocks.



Nipple Option

	Type		Nipple Size		Nipple Type	
			Section	Side	Standard	
Ball	ARC15	HRC15	-	M3	M3	A-M3
	ARC20	HRC20	-	M3	M3	B-M3
	ARC25	HRC25	ERC25	M6	M3	A/B-M6
	ARC30	HRC30	-	M6	M6	A/B-M6
	ARC35	HRC35	-	M6	M6	A/B-M6
	ARC45	HRC45	-	PT1/8	M6	B-PT1/8
Roller	ARC55	HRC55	-	M6	M6	A/B-M6
	ARR15	HRR15	-	M3	M3	A/B-M3
	ARR20	HRR20	-	M4	M4	A/B-M4
	ARR25	HRR25	-	M6	M6	A/B-M6
	ARR35	HRR35	LRR35	M6	M6	A/B-M6
	ARR45	HRR45	LRR45	M6	M6	A/B-M6
ARR55	HRR55	LRR55	M6	M6	A/B-M6	

GP-PT1/8-01 Lubrication Kit

The Lubrication Kit comes equipped with a supply nozzle (GT-1/8-M5) and three kinds of different nozzle adaptors (GH-M5-MR, GH-M5-06, GH-M5-08). The supply nozzle can be mounted on the main body of the common manual or pneumatic grease gun with PT1/8 tapped connectors widely available on the market.

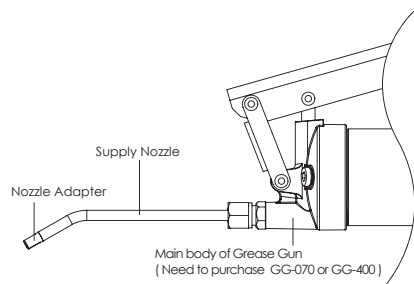

Greasing Diagram

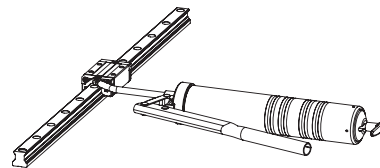

Supply Nozzle

Type	Dimension
GT-PT1/8-M5	

Nozzle Adapter

Unit: mm

Type	Dimension	Grease Nipple
GH-M5-MR		MR series Miniature linear guide size MR-15M · MR-15W MR-12M · MR-12W
GH-M5-06		A-M3 A-M3-L
		B-M3 B-M3-L
GH-M5-08		A-M6 A-M6-L A-M6-XL
		B-M6 B-M6-L B-M6-XL
		B-PT1/8 B-PT1/8L

Main body of Grease Gun

Option for the main body of the Grease Gun: GG-070 for 70g volume grease pack and GG-400 for 400g volume grease pack.

Unit: mm

Type	Dimension	Feature
GG-070		<ol style="list-style-type: none"> Pressure: 27Mpa Output Volume: 0.5~0.7 c.c/stroke Grease: Suitable for 70g volume grease pack or bulk loading
GG-400		<ol style="list-style-type: none"> Pressure: 62Mpa Output Volume: 1.0~1.2 c.c/stroke Grease: Suitable for 400g volume grease pack or bulk loading

cpc AR/HR Z Series Lubrication Storage Pad Testing Report

A linear guide is a category of rolling guidance systems. By using unlimited recirculating stainless steel balls that operate between the raceways of the rail and the runner block, the carriage achieves high precision and low friction linear movement. If the linear guides do not have sufficient lubrication, rolling friction will increase, causing wear and shortened linear guide lifespan.

cpc has added and embedded PU lubrication storage pads to prolong the life of the linear guide; the pads directly contact and lubricate the rolling balls. This design supplies sufficient lubrication even in short stroke operations.

cpc's design, due to the embedded pads absorption and retention capabilities, results in a product that features a long operation life and long-term lubrication.

Following are the results of cpc's in-house testing.

AR15 Lubrication Storage Pad Testing Data

Tested products: AR15 blocks with lubrication storage pads, 8 pieces, and AR15 rails, N accuracy grade, 1500mm Length, 4 pieces

Testing condition	
Rating load capacities(each Block)	1.8kN(C=9kN · C0=17.5kN)
Stroke	0.96m
Max running speed	1m/s
Lubricant	DAPHNE SUPER MULTI 68 [Viscosity64.32 CST 400C]
Lubrication period	No lubrication added during testing period

Testing equipment

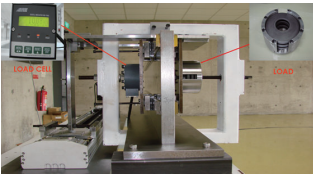

Testing result

Dried lubricant residue started appearing on rail profile, PU pads, and ball retainer of the tested blocks

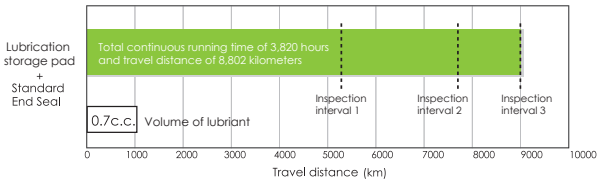

Test results at inspection intervals

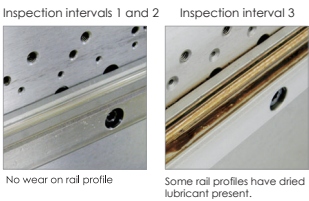

Inspection intervals 1 and 2: Lubrication Maintained

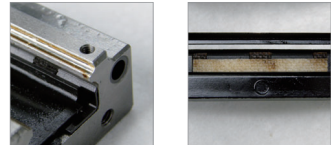

- Upward lubrication storage pads in good condition.
- Lubricant supply in good condition.
- No wear on the running profile of the rail.
- Downward lubrication storage pads in good condition.
- Lubricant supply in good condition.

Inspection interval 3: Lubricant residue

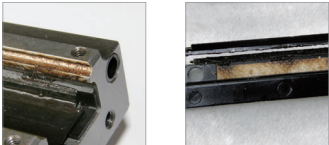

- Dried lubricant residue and breakage on the upward lubrication storage pads
- Dried lubricant residue and breakage on the downward lubrication storage pads.

Plastic parts and end seal in good condition

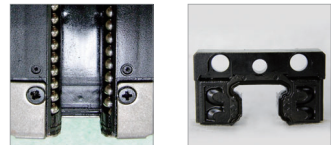

Plastic parts in good condition End seal in good condition

Test Summary

Total continuous running time of 3820 hours and travel distance of 8802 kilometers. Out of eight test blocks, dried lubricant residue appeared on 2 blocks and 1 rail. Dried lubricant residue is indicative of a need for relubrication and thus lengthens the operational life of the linear guide.

Linear Guide Service Life Calculation and Model Selection

Company /		Date (DD/MM/YEAR) /	
Address /		Tel /	
Contact /	Department /	Machine Model /	
Application(Axial) /	Amount required per Machines /	Sample Required Date (DD/MM/YEAR)/	
Application Drawing Provided? <input type="checkbox"/> Yes <input type="checkbox"/> No		Production Date (DD/MM/YEAR)/	
Assembly Specification / Way of Assembling			
<input type="checkbox"/> Horizontal <input type="checkbox"/> Vertical <input type="checkbox"/> Wall Hanging <input type="checkbox"/> Hanging on the Ceiling <input type="checkbox"/> Inclined 1(Degree: _____) <input type="checkbox"/> Inclined 2(Degree: _____) <input type="checkbox"/> Others (Please Draw a Sketch Above)			
Rails per Axial	<input type="checkbox"/> I (1)	<input type="checkbox"/> II (2)	<input type="checkbox"/> III (3) <input type="checkbox"/> Other _____
Blocks per Rail	<input type="checkbox"/> 1	<input type="checkbox"/> 2	<input type="checkbox"/> 3 <input type="checkbox"/> Other _____
Distribution of Blocks (mm)	l_0 : _____ (Distance Between Blocks on the same rail)		l_1 : _____ (Distance Between Adjacent Blocks on different rails)
Center of Mass of load(mm)	l_{mx} : _____	l_{my} : _____	l_{mz} : _____
Mass of Load (kg)	_____ (Please include mounting plate weight)		
Driver Position (mm)	l_{dz} : _____	l_{dy} : _____	
External Force Applying Position (mm)	l_{Fx} : _____	l_{Fy} : _____	l_{Fz} : _____
Axial Component (N)	F_x : _____	F_y : _____	F_z : _____
One Rail Per Axial			
Two Rails Per Axial			
Motion Specification			
Drive Mechanism	<input type="checkbox"/> Linear Motor <input type="checkbox"/> Ball Screw <input type="checkbox"/> Pneumatic Cylinder <input type="checkbox"/> Belt <input type="checkbox"/> Hydraulic cylinder <input type="checkbox"/> Rack and Pinion <input type="checkbox"/> Manual <input type="checkbox"/> Other _____		
Specification	Stroke Distance (mm):	Maximum Speed (m/sec):	
	Acceleration (m/sec ²):	Deceleration (m/sec ²):	
	Stroke Time (sec)	Frequency (hr ⁻¹):	
	Daily Operation Time (hr):	Expected Service Life (Year):	
Environment and Lubrication Requirements			
Environment	<input type="checkbox"/> General <input type="checkbox"/> Clean room(Grade/Class _____) <input type="checkbox"/> Vacuum / Low Pressure <input type="checkbox"/> Small Amount of Dust (Substance _____) <input type="checkbox"/> Large Amount of Dust (Substance _____) <input type="checkbox"/> Liquid (Substance _____) <input type="checkbox"/> Special Gas (Substance _____) <input type="checkbox"/> Other _____		
cpc Initial Lubrication	<input type="checkbox"/> Pre-lubricated (Regular Amount) <input type="checkbox"/> Pre-lubricated (Small Amount) <input type="checkbox"/> None <input type="checkbox"/> Other _____		
cpc Initial Antirust Method	<input type="checkbox"/> Apply Antirust Oil On the Surface <input type="checkbox"/> Apply Grease On the Surface <input type="checkbox"/> None <input type="checkbox"/> Other _____		
Customer Initial Lubrication	<input type="checkbox"/> cpc Grease only <input type="checkbox"/> In addition to cpc Grease Inject Customer's Grease (Grease : _____) <input type="checkbox"/> Remove cpc Grease And Inject Customer's Grease (Solvent: _____) (Grease: _____) <input type="checkbox"/> Other _____		
End User Re-lubrication Method	<input type="checkbox"/> Manual <input type="checkbox"/> Central Oiling System <input type="checkbox"/> None <input type="checkbox"/> Other _____		